

RADIO CONSTRUCTOR

for the Radio and Television Enthusiast

RADIO CONSTRUCTOR

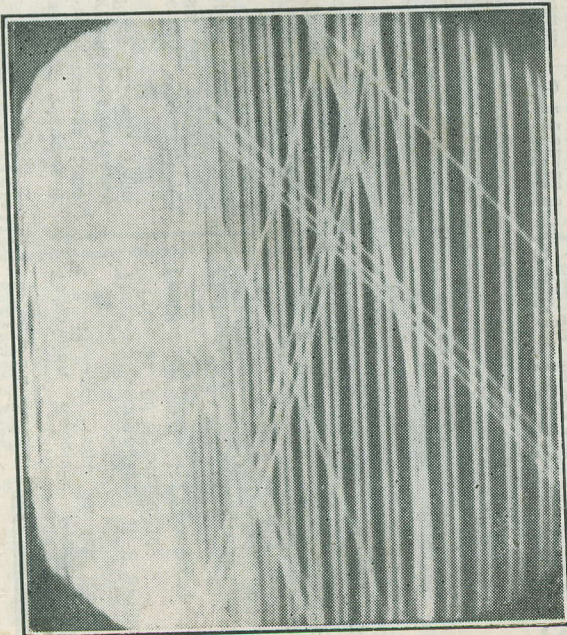

?
**WHAT
IS
WRONG**
?

This, and many other faults, are described and illustrated in our latest publication . . .

TV FAULT FINDING

Data Book Series No. 5

This is a completely new production—not a reprint—and is unique in that it is lavishly illustrated by photographs taken from the screen of a television exhibiting the faults under discussion. A handy fault-finding guide is incorporated, and this is cross-referenced to the book itself.

100
illustrations and diagrams

80
pages, high quality paper with heavy art board cover

PRICE 5 SHILLINGS, Postage 3d.

Available from your usual supplier, or direct.
(Trade enquiries invited)

AMALGAMATED SHORT WAVE PRESS LTD.
57 MAIDA VALE, LONDON, W.9.

Tel.: CUN 6518

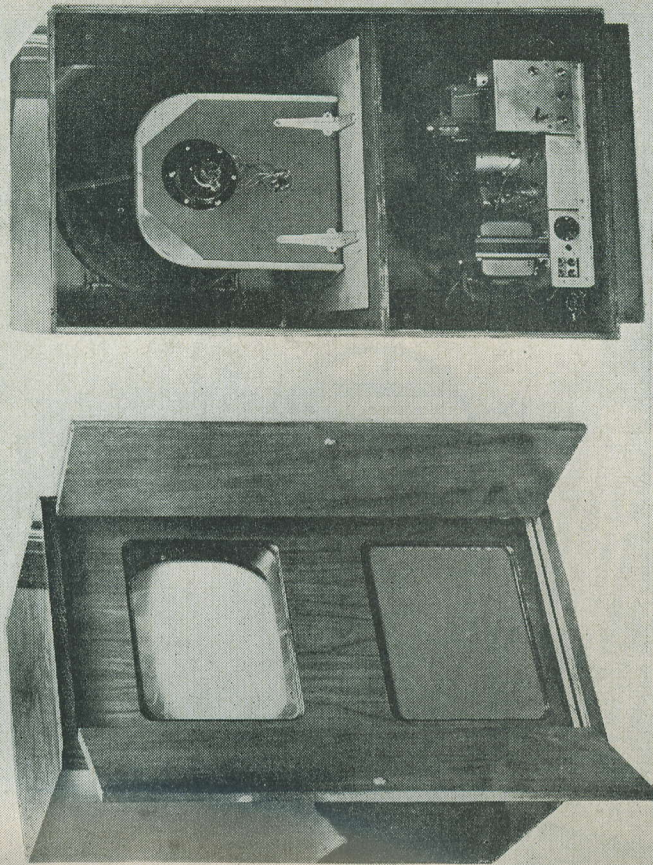

LARGE SCREEN T.V.

IN THIS ISSUE . . .
RADIO CONTROL TRANSMITTER · MULTI-RANGE AC/DC VOLTMEETER · 4 VALVE PUSH-PULL SUPERHET · SURPLUS MOTOR GENERATORS · Easily Calibrated Slow Motion Drive · That Professional Finish · Suggested Circuits · Query Corner · Mainly for the Beginner · Kit and Component Reviews
etc., etc.

16

ALL-ROUND DEPENDABILITY

Precision ELECTRICAL MEASURING INSTRUMENTS

Dependability is an essential quality in any good electrical testing instrument. Absolute dependability is the outcome of good design, suitability for purpose, and a high standard of accuracy. These and a high standard of accuracy are also indispensable factors which are also all "AVO" Instruments. compact port noteworthy for their construction. When you can depend on "AVO". When choosing instruments, consult our complete catalogue, a copy of which may be had free on application.

THE AUTOMATIC COIL WINDER & ELECTRICAL EQUIPMENT CO. LTD.
WINDER HOUSE • DOUGLAS STREET • LONDON S.W.1. Telephone: Victoria 3404-9

**ADVANTAGES OF THE
'ENGLISH ELECTRIC'
METAL C.R. TUBES**

4. The Ion Trap

Conventional assembly methods and parts are used for the electron gun of the 'ENGLISH ELECTRIC' C.R. Tube T.901, but there is one feature that deserves to be noted. This is the Ion Trap, fitted to prevent ion spot or "burn" which could otherwise spoil the picture. The electron gun of the T.901 is so made that negative ions are removed from the electron beam and cannot therefore reach the tube screen and cause "spotting." *Blemish or "burn" will not occur with the 'ENGLISH ELECTRIC' T.901 tube under normal working conditions.*

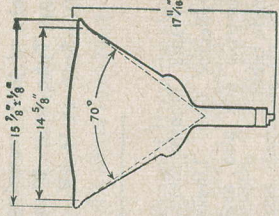

PRICE £24.6.5

Tax paid

BRITISH MADE BY 'ENGLISH ELECTRIC'

For full technical details and price for quantities write to:-

THE ENGLISH ELECTRIC COMPANY LTD., TELEVISION DEPT., QUEENS HOUSE, KINGSWAY, LONDON, W.C.2



Editorial

We understand that there were good attendances at the Northern Radio Exhibition recently held at Manchester, and that a great deal of interest was shown in the items on display there. Unhappily, the amount of business transacted was somewhat disappointing. This, of course, is only to be expected in view of the trade depression now prevalent in the textile industry, which is concentrated mostly in the area served by the exhibition.

It is under circumstances such as these, when money is "tight," that the radio constructor scores over the less knowledgeable—particularly if he has been wise enough to stock up the "junk box" under favourable conditions. Although there is not nearly so much ex-WD equipment available now as there was a year or so ago, there are still many useful items at reasonable prices for the reader who is prepared to do some searching.

It should not be thought from the above that we advocate the use of surplus components on all and every occasion. We should not, for example, dream of using anything but new, and therefore the most reliable, if more expensive, components when building test equipment—and the same policy applies in many other circumstances. Even so, we must remember that many readers simply cannot afford the higher prices. In that case, obviously half a loaf is better than none.

CONTENTS

Suggested Splitting Detector, by G. A. French	422
In Your Workshop, by J.R.D. - Radio Control Of Models: A Simple Transmitter, by A. C. Gee, G2UK	423
Book Reviews	425
Large Screen TV—The Radio Constructor's 16" Televisor, Part 5	427
That Professional Finish, by A. W. Wood, B.Sc.	428
Trade Review: Burgoyne Tape Table	434
Radio Miscellany, by Centre Tap	435
Query Corner	436
A Multi-Range AC/DC Voltmeter, by S. D. Dean	439
Mainly For The Beginner—Hum, by H. E. Smith, G6UH	444
A Handy Locating Jig, by A. Torrance	446
Away From The "Four Plus One," by F. L. Bayliss, A.M.I.E.T., Part 4	449
Not So Dusty Vision, by "Technician"	450
Easily Calibrated Slow Motion Drive, by Norman F. Webb	453
Kit and Component Reviews	454
Uses For Surplus Motor Generators, by T. H. O'Dell	456
From Our Mailbag	458
Abbreviations, Symbols and Simple Formulae, Part 1, by H. E. Smith, G6UH	459
	460

RADIO CONSTRUCTOR

IN EVERY RADIO SET THERE ARE
500 reasons why you should use . . .



The average radio set contains about 500 soldered connections — make sure of perfect reception by using only Ersin Multicore for all soldering on your equipment. The three cores of extra - active non-corrosive Ersin Flux not only prevent the formation of oxides, but actually clear the oxides from the metal to be soldered, saving time and trouble, and ensuring the highest standard of sound precision soldered joints.

MULTICORE SOLDERS LTD.

Multicore Works, Maylands Avenue, Hemel Hempstead, Herts. Boxmoor 5636 (3 lines)

TELEVISION CABINETS

All Sizes up to 16" Tube

Specially Designed for 'Radio Constructor' Set, and Illustrated on this Month's Front Cover.

Price **£18:10** Carriage £1

SEND FOR ILLUSTRATED LEAFLET

H. ASHDOWN

98¹/₂HERTFORD ROAD, EDMONTON, N.9
 TOT 2621

ARTHURS HAVE IT!

LONDON'S OLDEST RADIO DEALERS
LARGE VALVE STOCKS
 AVOMETERS IN STOCK

Avo Test Meters and Signal Generators and Taylor Meters.
 Leak Point One Amplifiers and Tuning Units.
 Chapman Tuning Units.
 Crystal and Moving Coil Mics.
 Decca Replacement Heads and Goodman's Axiom 150 Speakers.
 Partridge Output Transformers for Williamson Amplifier.
 All Components for the Radio Constructor's 16" Televisor.
 Wire-wound volume controls, etc.
LATEST VALVE MANUALS
TELEVISION SETS, WIRE AND TAPE RECORDERS ALWAYS IN STOCK
 Goods offered subject to price alterations and being unsold.

Est. 1919

Arthurs first

PROPS: ARTHUR GRAY LTD.
 OUR ONLY ADDRESS: **Gray House**
 150-152 Charing Cross Road
 London, W.C.2

TELEPHONE 58331-4 and 4765 WRITE FOR LISTS

COMPONENTS FOR WIDE ANGLE SCANNING

A new line/scan transformer capable of fully scanning any Cathode Ray Tube from 9" to 16" (Double D). Scan at 16 kV.

Frame Transformers, Focus Coil, Deflector Coil. Linearity and Width controls are also available for wide angle tubes.

Full details sent on request, please send SAE.

ALLEN COMPONENTS, LTD.,
 Crown Works, 197 Lower Richmond Road, Richmond, Surrey.

Tel.: PRO 4463.

Advantages

Even when used in a normal AVC-controlled superhet, the circuit still shows its advantages. These are given by the fact that the following AF amplification is in push-pull (as mentioned above), that the necessity for an additional phase-splitting valve is avoided, that the only distortion introduced is that given by a normal diode circuit (this distortion usually appearing only at very low signal levels or on the reception of heavily modulated carriers), and that hum which may be picked up by the cathode of an AF phase-splitter does not occur in this circuit. (Should it be possible for hum to be picked up on the cathode of the diode, the valve should be replaced by a Westector or germanium diode).

The circuit has one disadvantage. This is given by the fact that two volume controls (R5 and R6), are needed, and that these must be fairly accurately ganged. This disadvantage becomes important when the circuit is being put into practical use, as two-gang potentiometers are somewhat difficult

to obtain. The problem would probably be met most easily by the use of two identical potentiometers ganged together by a simple external mechanical coupling. When the detector is used at a high RF voltage level in the manner mentioned above the potentiometers can be replaced by fixed resistors, volume being controlled in the RF or IF stages.

Functioning

The functioning of the circuit is almost self-explanatory. The diode load is made up by the two resistors R3 and R4 in series. By centre-tapping these resistors and arranging the other detection components symmetrically about the centre-tap, phase-splitting is automatically ensured. The tuned circuit feeding the detector should not, of course, be centre-tapped, and it should be free from earth. If AVC is desired, this may be obtained via R7. The high value shown for this resistor is recommended in order to prevent it upsetting the balance of the circuit. When AVC is not required, R7 and C6 can be omitted.

IN YOUR WORKSHOP

In which J. R. D. discusses Problems and Points of Interest connected with the Workshop side of our Hobby, based on Letters from Readers and his own experiences.

The enthusiasm of radio amateurs is well known. They have, by reputation, an ability to conjure up the most advanced equipment out of what is, in many cases, a very varied collection of component parts. And they do this, as well, for a cash expenditure which is often quite small.

Most amateurs make their equipment look pleasing and "professional" as a matter of course. What they build not only works well; it looks well. As they say in Devon: "a praeper job"!

However, attention to appearance in finished installations argues the possession of some patience on the part of the builder. Especially is this true when particularly boring and tedious jobs have to be carried out. An example of this occurred recently in the writer's own shack.

Cleating
This shack, in common with many others, has a large number of cables running around the walls. These cables consist of mains leads; power supplies from a main power unit; AF leads for speakers, amplifier, pick-up, etc.; and several others. As these wires have been added to from time to time in the past, their general appearance was more than untidy.

The writer (who has been putting off the job for some time!) finally made up his mind to get them properly cleated down. Lead-covered cable was available for the mains leads, and the AF was carried by screened cables. There would therefore be no objection to running all the wires together side by side. There was one twisted flex lead which could not, of course, be held under metal

Suggested Circuits for the Experimenter

The circuits presented in this series have been designed by G. A. FRENCH specially for the enthusiast who needs only a circuit and the essential relevant data.

No. 19—A Phase-Splitting Detector

In high-fidelity receivers employing push-pull output it is normal practice to use a phase-splitting valve after the detector. An AF amplifying stage may be connected between the detector and the phase-splitter, in which case the phase-splitter usually feeds the output valves directly; or the phase-splitter may be employed immediately after the detector, whereupon several AF amplifying stages in push-pull are usually required to bring the signal to loudspeaker strength.

This month's circuit illustrates an alternative system, by means of which phase-splitting is obtained at the detector itself. Such a system has several advantages, the most important of these being that all the following AF amplification is carried out by push-pull circuits. The circuit is at its most useful

when detection occurs at a high RF voltage level. In this case the detected AF has a relatively high voltage, and subsequent AF amplification need consist only of two output valves in push-pull; almost ideal conditions being obtained when these valves are triodes (possibly with negative feedback) giving consequent harmonic cancellation in the speaker transformer.

The provision of a high RF voltage to the detector does not present many problems. Sufficient RF voltage should be obtained on local stations from a frequency-changer and IF stage alone, provided that a good aerial is used and AVC is dispensed with. Two RF stages in a TRF circuit may, if well-designed, possibly give nearly as high a voltage.

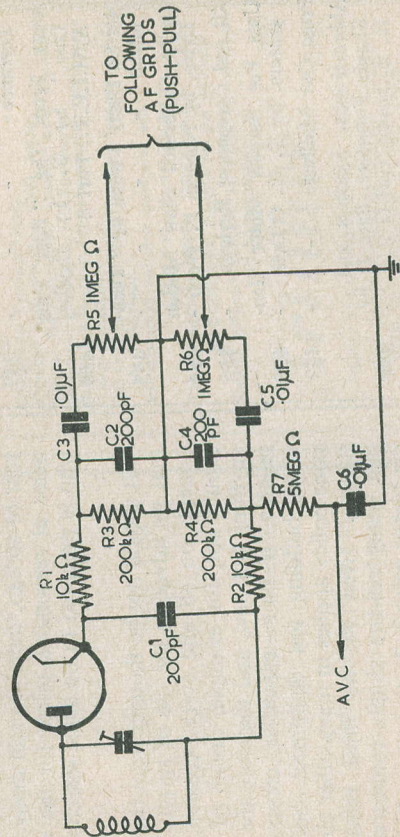

connecting them at the other or at any intermediate places. If cleating is then started at the first end, all the kinks and twists in the wiring are automatically cleared as cleating proceeds; and the lengths of cable required work out automatically also. (It is, of course, obviously essential to see that all the cables are long enough in the first place, allowing especially for corners, etc.) Lead-covered cable should be treated particularly carefully since, should it kink, it will be difficult to straighten out again and may even suffer damage. This sort of cable will lie flat after cleating if a long, flat piece of wood is held against it and lightly tapped.

The cleats were spaced at seven-inch intervals. The writer's eye is not sufficiently experienced for a job of this sort, and he made certain of the spacing by using a rule. This only took a few extra seconds, and the time spent was amply justified by the final appearance. Care was also taken to see that the cleats were in a straight line, this being done by checking from the edge of the bearer.

On completion, the cleated cabling certainly looked quite neat and effective. When several friends looked in and asked what would happen when he wanted to put up some more leads in the future the writer had his answer ready. He had already included several spare cables, at present unused, which were ready for just such a future emergency!

Lead-covered Cable
A reference was made earlier to the possibility of damage to lead-covered cable by kinking. Lead-covered cable is an easy wire to handle, but it would not be inappropriate to point out here that it should also be treated carefully when it is being stripped.

Some people remove the lead covering by making two depressions in it on either side of the cable with a pair of snips or a similar tool. They then bend the wire backwards and forwards about the depressions until the lead covering tears and can be pulled away.

This method is incorrect. The original depressions and the process of bending causes the end of the lead covering remaining in the cable to turn inwards, whereupon it might damage the internal insulation. The bending also causes weaknesses in the conductors. The best way to strip the covering consists of lightly running a sharp knife all round it. If the knife-cut is sufficiently deep, the lead covering comes away with only a slight amount of bending, and the end remaining on the wire presents a clean break without turning inwards.

Fitting The Cables
When the paint on the bearers had dried, they were screwed to the wall. The wires were then cleated to them. In cases like this, a good plan consists of leaving the wires connected at one end of the run and dis-

connecting them at the other or at any intermediate places. If cleating is then started at the first end, all the kinks and twists in the wiring are automatically cleared as cleating proceeds; and the lengths of cable required work out automatically also. (It is, of course, obviously essential to see that all the cables are long enough in the first place, allowing especially for corners, etc.) Lead-covered cable should be treated particularly carefully since, should it kink, it will be difficult to straighten out again and may even suffer damage. This sort of cable will lie flat after cleating if a long, flat piece of wood is held against it and lightly tapped.

The cleats were spaced at seven-inch intervals. The writer's eye is not sufficiently experienced for a job of this sort, and he made certain of the spacing by using a rule. This only took a few extra seconds, and the time spent was amply justified by the final appearance. Care was also taken to see that the cleats were in a straight line, this being done by checking from the edge of the bearer.

On completion, the cleated cabling certainly looked quite neat and effective. When several friends looked in and asked what would happen when he wanted to put up some more leads in the future the writer had his answer ready. He had already included several spare cables, at present unused, which were ready for just such a future emergency!

Lead-covered Cable
A reference was made earlier to the possibility of damage to lead-covered cable by kinking. Lead-covered cable is an easy wire to handle, but it would not be inappropriate to point out here that it should also be treated carefully when it is being stripped.

Some people remove the lead covering by making two depressions in it on either side of the cable with a pair of snips or a similar tool. They then bend the wire backwards and forwards about the depressions until the lead covering tears and can be pulled away.

This method is incorrect. The original depressions and the process of bending causes the end of the lead covering remaining in the cable to turn inwards, whereupon it might damage the internal insulation. The bending also causes weaknesses in the conductors. The best way to strip the covering consists of lightly running a sharp knife all round it. If the knife-cut is sufficiently deep, the lead covering comes away with only a slight amount of bending, and the end remaining on the wire presents a clean break without turning inwards.

Radio Control of Models

by

A. C. GEE, G2UK

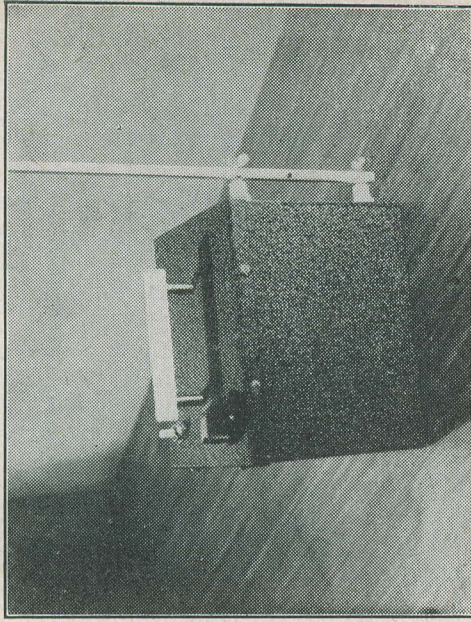

In the last article in this series, we described a two valve receiver suitable for sequence control. We promised at the end of that article to describe a miniature transmitter for use with the receiver and this instalment accordingly deals with the construction of such a unit. That described herewith is the one used by the writer for controlling the receiver previously described.

As can be seen from the circuit diagram, a straightforward push pull circuit is used, two Mullard DL92 miniature valves being chosen, as these will operate very efficiently with 85 volts HT, which can be conveniently supplied by a Drymax 529 HT battery. The dimensions of this battery are only $6 \times 3\frac{1}{2} \times 2\frac{1}{4}$ inches. Used in conjunction with a Drydex Type H1158 LT battery, the size of which is $4 \times 2\frac{1}{2} \times 2\frac{1}{4}$ inches, these two can be conveniently arranged so that quite a small cabinet can be used as shown in the photographs. This was made for us by Philipotts Metal Works Ltd., Chapman St., Loughborough, and measures $6\frac{1}{2} \times 5 \times 5$ inches. The two batteries arranged in the box as shown leave a small space $2\frac{1}{4} \times 3\frac{1}{4}$ inches into which the transmitter fits. It is built up on a piece of paxolin sheet, which stands on four 'feet' 2 inches high. The general position of the components can be seen from the photos. Construction and circuitry are straightforward and need little comment. The tuning coil consists of 12 turns of 22 swg enamelled wire wound on a $1\frac{1}{4}$ inch former.

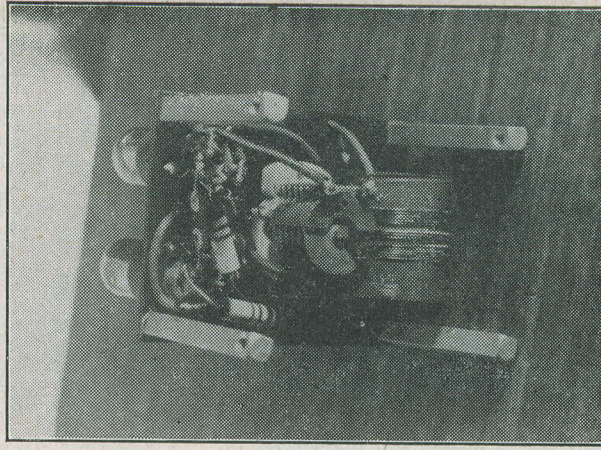

Above: View of completed transmitter.
Below: View of chassis showing tuned circuits.

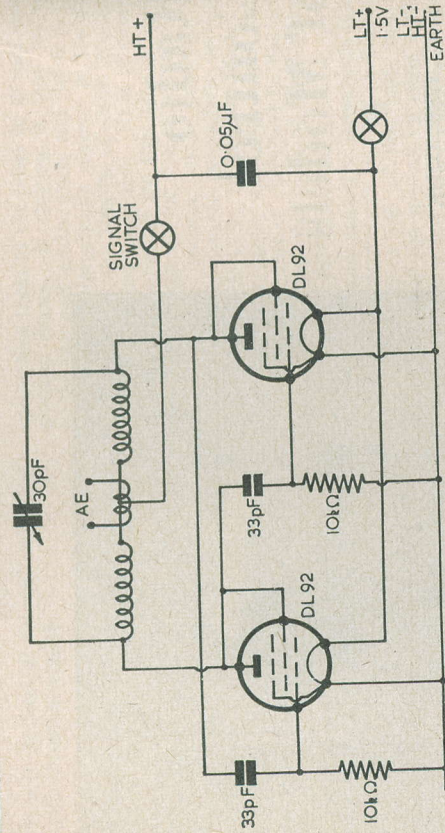

C671

Simple transmitter for sequence control. See April issue for associated receiver and DL92 base connections.

This coil is split into two sections, as shown in the circuit, a space of about 1/4-inch being left between the two parts. Into this space is wound the aerial coil. Some experimenting may be needed to get the coupling between the main tuning coil and the aerial coil just right. In our own unit, three turns proved satisfactory. Too many turns will lead to hand capacity effects and poor frequency stability, whilst too few will give a poor energy transference to the aerial, with consequent unreliable receiver action.

The keying or signal switch is of the push-to-make push-to-break variety and is fitted to the lid of the cabinet. This arrangement will be found quite convenient and will help to eliminate the hand capacity effects so often experienced when long leads to the keying switch are used. As the unit is so small, it can be held in the hand or placed conveniently on the ground. The other switch shown on top of the case is the LT on/off switch. The aerial consists of a 5-ft. length of whip aerial fitted to two stand-off insulators as

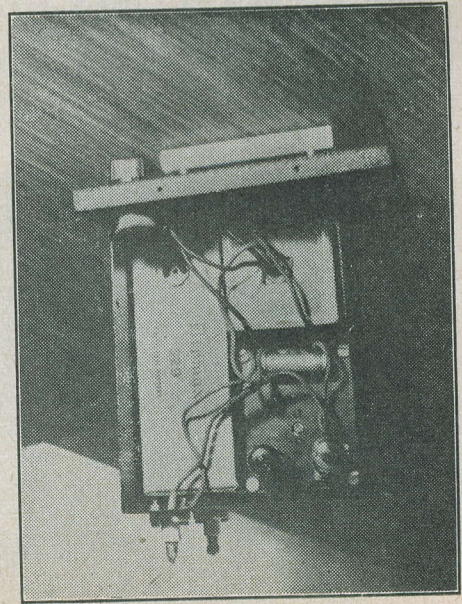

View of chassis from valve side, showing arrangement of batteries.

shown. The lower one of these is connected to one end of the aerial coil, the other end of the coil being earthed to the case. If hand capacity effects are troublesome, the case should be earthed, using a fairly stout earth-pin, but, as already mentioned, adjustment of the coupling between the aerial and the tuning coil should correct any tendency in this direction. A dipole aerial with each feeder leg coupled to the ends of the aerial coil would work very well indeed with this transmitter.

There should be absolutely no trouble at all in getting the transmitter to work. After it is wired and checked, connect up batteries and switch on. Locate the carrier on the receiver (the station receiver that is). It should show up somewhere around 26 to 28 Mc/s. By means of the variable tuning capacitor, tune it into the 27 Mc/s R/C band and then line up the R/C receiver on it as has been described before.

The next series on this subject will be contributed by Mr. F. C. Judd, G2BCX, well known as development engineer for "Flight Control." We are very pleased to welcome him to these pages, and we can assure our readers that he will be able to give us the very latest in the field of R/C.

Book Reviews

PRINCIPLES OF RADIO (Sixth Edition), by K. Henney, B.A., M.A., and Glen A. Richardson, B.S., M.S. 655 pages, over 400 illustrations. Price 44s. Published by Messrs. Chapman and Hall, Ltd., 37 Essex Street, London, W.C.2.

The preparation and publication of a reference book that embraces almost all aspects of radio communication theory and presents such a wide subject in clear and understandable language is, undoubtedly, an ambition to which many an author has aspired. In this volume the co-authors have succeeded to a large degree, and are to be commended for their very adequate treatment of basic principles without introducing difficult mathematics; their method will surely appeal to the vast majority of students who do not like to be tortured with hieroglyphical hidrosis.

About one third of the book is taken up by the first nine chapters, in which the reader is gently but firmly educated in those important fundamentals, magnetism, inductance, capacitance, properties of A.C. and D.C. circuits, resonance, and kindred subjects. The next seven chapters deal with thermionic valves and their application as detectors, amplifiers, and oscillators. From this section of the book the reader can seek and find practically all he needs to know on such matters, and is given sound knowledge on the interpretation of characteristic curves, audio design, rectifier and power supply apparatus, and receiver practice.

There follows some discussion on amplitude-modulated transmitters, transmission lines, aerials and propagation, frequency modulation and detection. The chapter on ultra-high frequency phenomena introduces the reader to the complex problems of the technique, and gives up-to-date information on such things as lightwave triodes, klystrons and magnetrons, cavity resonators and wave guides.

A chapter on electronic measuring apparatus is devoted to valve-voltmeters, cathode-ray oscilloscopes and

Q-meters. A rather short section deals with wave shaping circuits and multivibrators, and a brief chapter on television principles presents a rough idea of the fundamentals of this branch of electronics. The book concludes with a small chapter giving the basic conception of radar.

This publication represents good value and can be recommended to those who want to secure a good grounding in essential theory; it forms an admirable introduction to more serious study. It is liberally sprinkled with some 260 problems intended to enable the reader to obtain practice in solving typical design formulae, but as the answers to the questions are not given the student will not be able to check his working. As the book is of American origin, English readers will expect to notice many terms and phrases which at first will be unfamiliar, but these are easily reconciled with the English terms. The type-face and diagrams are particularly clear, and the book is notably free from errors. A useful index, and the sectionalized chapters, are also pleasing features.

TELEVISION PRINCIPLES AND PRACTICE, by F. J. Camm. 215 pages, 144 illustrations. Price 25s. Published by George Newnes, Ltd., Tower House, Southampton Street, Strand, London, W.C.2.

The formula used for compiling this book seems to have been the simple process of choosing about a dozen titles of articles that have appeared in the pages of Newnes' monthly journal "Practical Television." One is presented with a general description of how television works from transmitter to receiver, in a manner which is most likely to appeal to readers with very little technical knowledge but who want to learn some of the underlying principles of the technique. For this reason the treatment is essentially non-mathematical.

A fairly clear insight can be obtained of the system of transmission used by the B.B.C., the principles of television cameras, and the way scenes are converted into electrical radiations and subsequently re-converted into moving pictures by the receiver. Projection receivers are dealt with in some detail and certain circuits peculiar to them are well described. The pioneer work of Baird, and the later investigations of some American laboratories, in the specialized fields of stereoscopic and colour television are given notes.

The chapter on time bases would have been more complete with the inclusion of some reference to magnetic deflection oscillators and amplifiers; as it is, the chapter concentrates on electrostatic deflection, and readers having familiarity with such circuits will identify those given as belonging to the cathode-ray oscilloscope rather than the television set.

D.C. receivers are briefly discussed, and the many types of aerial and their chief characteristics are clearly presented. The chapter on servicing will be of general interest, though it would seem doubtful whether a person seeking basic knowledge could be the type who might venture to tackle a television receiver fault so early in his career! A few of the many forms of interference, and their causes, are given a few pages; a short chapter on choosing a receiver indicates some of the desirable features to be considered in a television installation.

In Chapters IX and XII, the reader is suddenly confronted with two short, constructional articles on a London-Birmingham Converter and a Pattern Generator. They are undoubtedly useful in themselves for those who need them, but these chapters seem rather out of place in a book whose predominating feature is the broad treatment of principles.

Some space is devoted to the recommendations of the Beveridge Report, and the book concludes with a dictionary of television terms which takes up a fifth of the total pages. Although useful as a reference, it nevertheless contains many terms rarely if ever encountered in present-day television parlance. This last section of the book tends rather to detract instead of add value to a volume which, having regard for its contents, is priced at a figure that elevates it from the "popular" class to which it seems most fitting.

LARGE SCREEN TV.

THE RADIO CONSTRUCTOR'S 16 inch TELEVISOR

PART FIVE

In this article will be found details of the chassis dimensions and suitable layouts and dispositions for the smaller components.

Readers who have been following this design will at once notice that the valve line-up as seen in the photograph differs from that given in the previous text. Further experiments with the timebases were undertaken, and it was discovered with some

satisfaction that for some valve positions alternative types functioned perfectly.

Thus, the 6SN7 replaced the 12AU7, and both the Osram KT61 and the Brimar 6AG6 substituted for the N78 (Note: The N78 was definitely the best for the video stage). For the EHT rectifier the U37 or the R16 were both excellent.

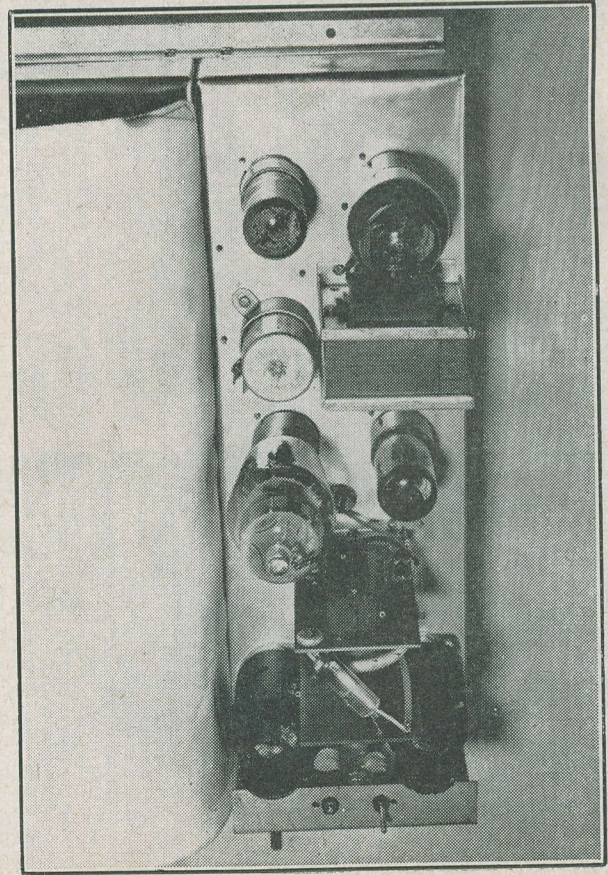

Timebase—Top view.

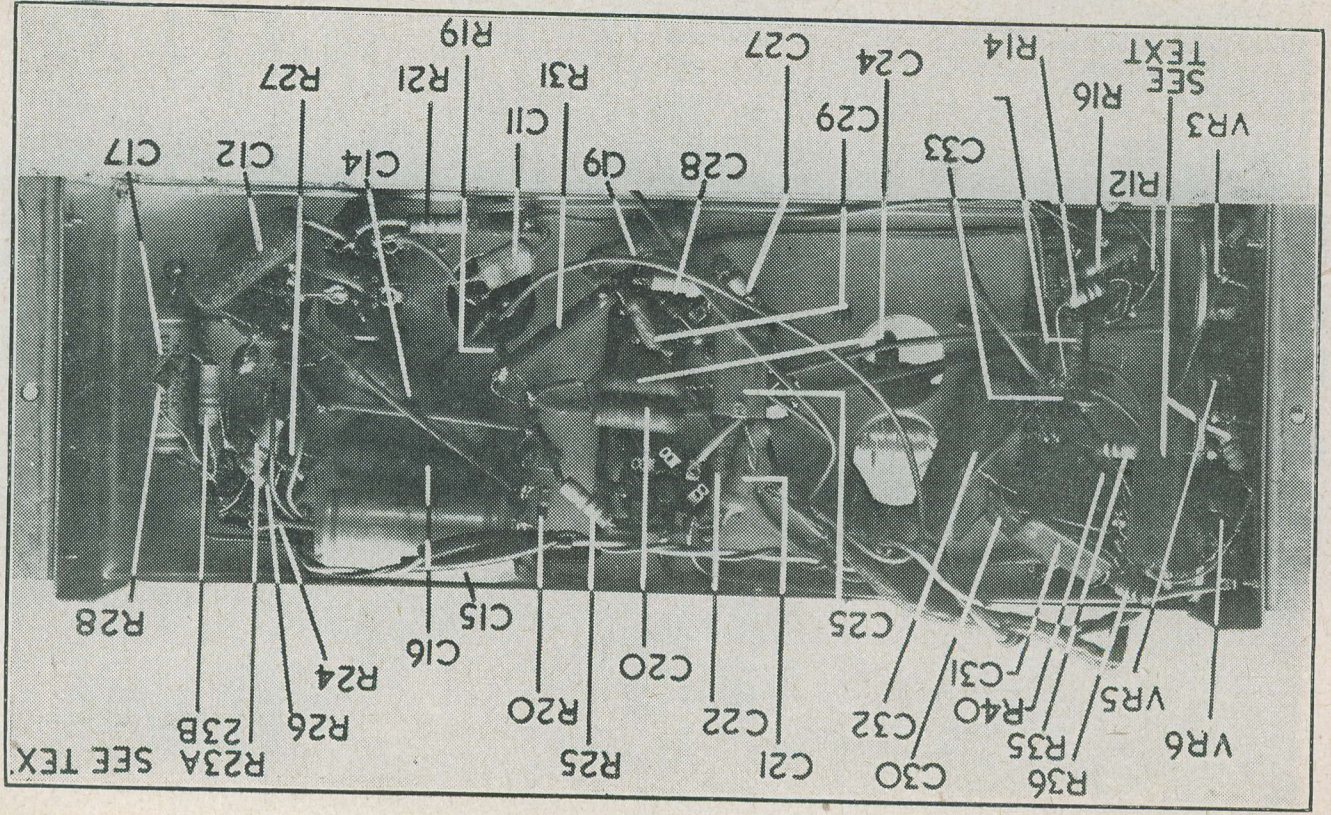

Timebase—Underneath Guide.

Suppliers of components mentioned in this article

Cabinet.	H. Ashdown, 98 Hertford Road, London, N.9. (See advert on page IV)
Chassis.	F. J. Hill, 48 Baldwin's Park, Bexley, Kent.
Condensers.	Telegraph Condenser Co. Ltd.
Rectifier (14A/342).	Westinghouse Brake and Signal Co. Ltd., 82 York Way, King's Cross, London, N.1.
Choke (181). Auto-transformer (AT310/A)	Allen Components Ltd. (See advert on page IV)

Constructors should therefore determine their final valve line-up before drilling the chassis or before ordering. Those who prefer this arduous task already carried out will find the chassis maker's name in the list inserted in text.

Returning to the timebase, the screening cans for the line oscillator and the sync separator are necessary. This is because of their proximity to the line output transformer. However, suitable screens are readily obtainable for whatever types of valve are used.

Some "trial and error" experimenting is required with R23. This resistor was found to produce better frame linearity in our model when using a 6.8 k Ω and a 47 k Ω in parallel. The top few lines will be affected and better spacing achieved. A further means of securing control over frame linearity is the addition of a small 500 Ω variable in series with R28.

It was stated earlier that Allen Components Ltd., would be supplying the line output transformer with or without the EHT rectifier valve. Unfortunately, due to packing difficulties this has not been found practicable.

Constructors should observe the high voltage method of soldering in the rectifier, which is attached by its own protruding electrodes.

Short lengths of polystyrene sleeving should be slipped over these, and nicely "blobbed" solder built up to prevent corona discharge. Your writer has found it a good procedure to paint these joints and sleeving right through to the glass of the valve with polystyrene cement.

C26 was mounted on a small bracket inside the tube installation, close to the front clip, connection to this being made direct

from R34. The earth connection for C26 is conveniently available on the seven pin socket at the rear of focus board.

Note: It is not intended that the illustration showing the position of small components under the chassis should be rigidly adhered to, but it will present a fair idea of a reasonable layout. The writer must confess that one resistor and condenser should not have appeared in the photograph; attempts to improve the timebase were continually being made, and the final arrangement has been made known to you. So no bricks, please!

The final chassis arrangement—see cover illustration—comprised three units, timebase, power pack and vision and sound chasses, which were held together by "L" strip. The cabinet, photographed from front and rear, was made to measure for this design, and is a delightful piece of furniture which would grace any home. These cabinets are now available, accurately prepared, to the constructor.

Four holes are provided on the side, and by mounting the four controls on a metal plate, this may simply be screwed on to the interior of the cabinet. These controls are, of course, Focus, Brilliance, Volume and Contrast. Engraved knobs give a finished appearance.

The reader is now in a position to line up and establish a good raster, and it is suggested that the low rail HT voltage be used (see last month's article). The change-over to higher voltage is effected after establishing linearity and normal scan. Better focusing may be expected, however, when both vision and sound current loads are passing through the focus coil, or by temporarily raising the value of R42 from 500 Ω 3W to 1,000 Ω 3W.

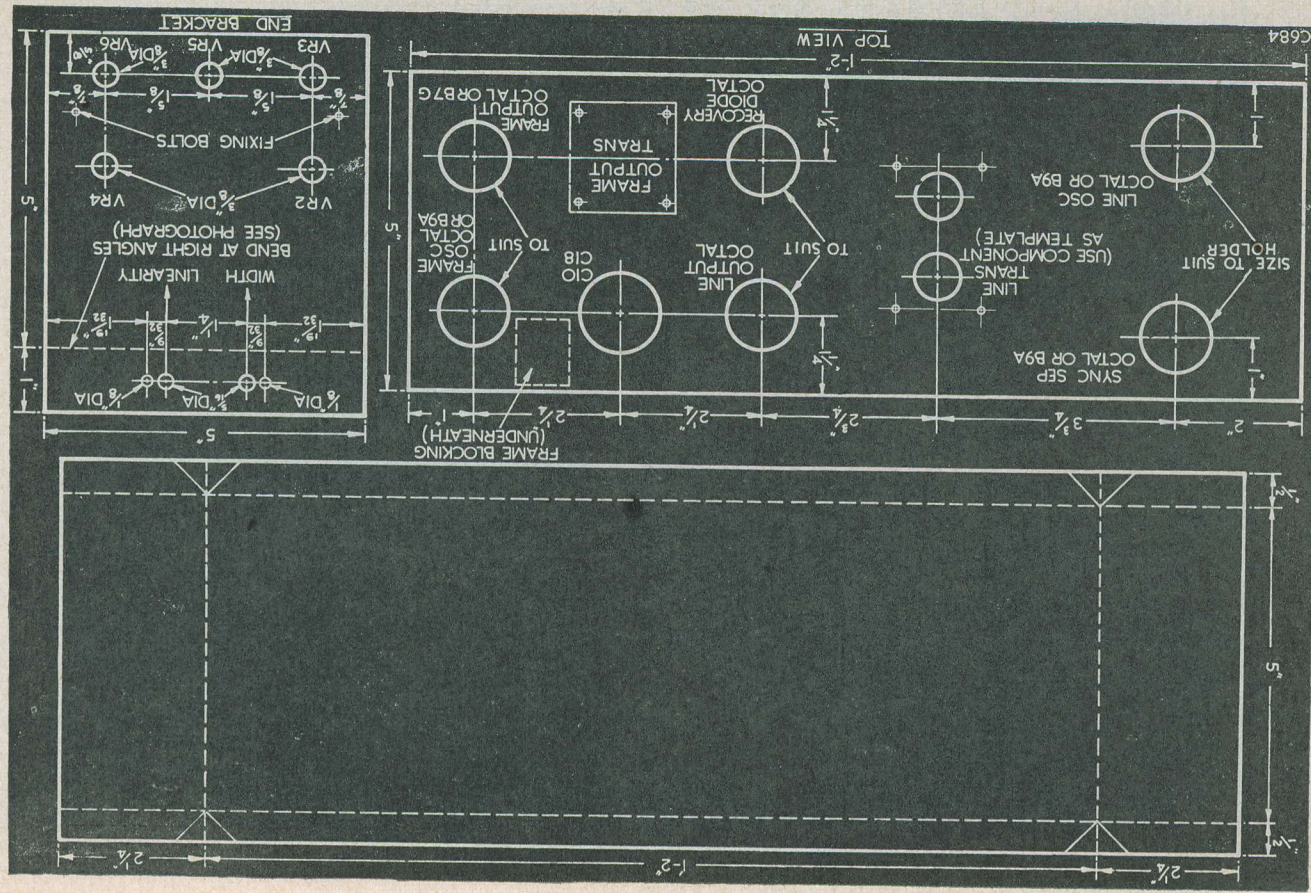

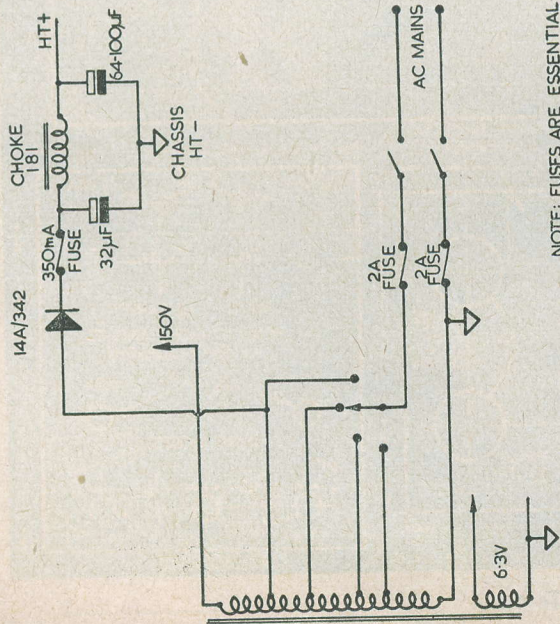

C682

NOTE: FUSES ARE ESSENTIAL

Suggested power pack utilising auto-transformer.
 Note: Reservoir condenser should be connected directly after rectifier, and before the fuse—not as shown.

While on the subject of power requirements, your attention is drawn to the Westinghouse mains rectifier type 14A/342. With this, suitable supplies can be economically obtained from the normal 200 to 250V AC mains input. The main consideration is the reservoir condenser.

The accompanying diagram fully illustrates this. A filament transformer for 6.3V at 9-10A, which will also heat the tube, may be purchased at a reasonable price.

The power supply circuit shown is capable of excellent ripple suppression and is perfectly satisfactory for television. In point of fact, the actual residual ripple is approximately 2 to 3 per cent., which may be con-

sidered as negligible for practical purposes. The makers of the rectifier, the Westinghouse Brake and Signal Co. Ltd., 82 York Way, King's Cross, London, N.1., willingly provide any technical information required, and readers resident in areas with peculiar or unusual power supplies would do well to consult them.

Some further considerations are necessary for those who wish to use 9" or 12" tubes for the time being (see last month's article). One suitable method would be an isolation transformer with tapped primary and a secondary of about 150V. Under these conditions the same rectifier would function well.

Direct AC mains supply. A heater transformer is required in addition—see text.

Note: Remarks in diagram above concerning the reservoir condenser and fuse also apply here.

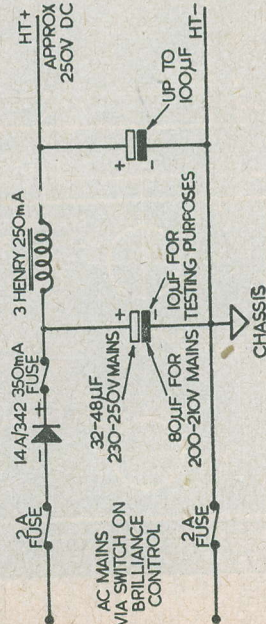

C683

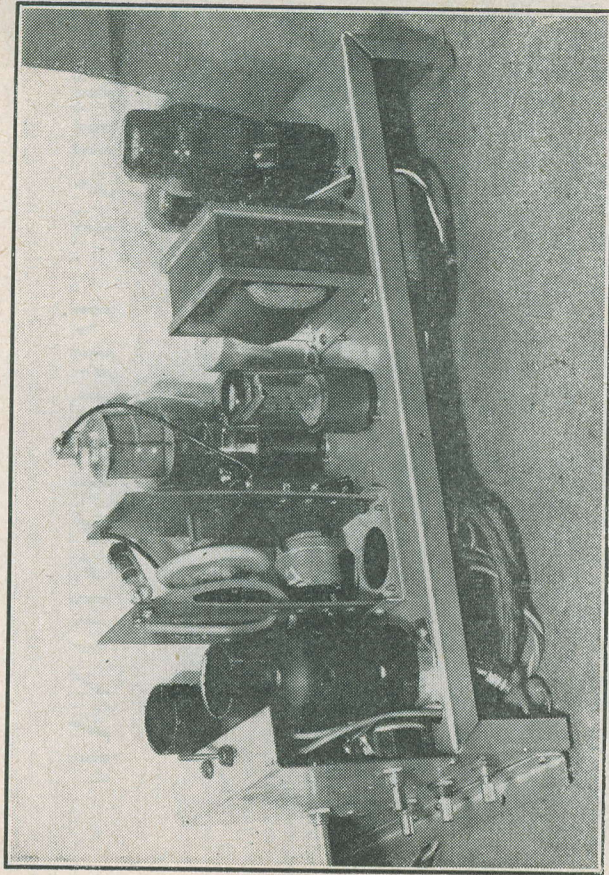

Timebase—Side View.

Still another method, and one with considerable saving in bulk and self-contained heater supply, is the auto-transformer. A suitable circuit is shown, and readers planning to start with a 9" or 12" tube will see at once that there is a 150V tapping—an ideal supply.

One reader has asked if the Brimar RM4 metal rectifier from his "Viewmaster" is satisfactory for this function. The answer is, of course, that it will work perfectly.

Note: Circuits employing auto-transformer or mains metal rectifier should not be externally earthed, and the fusing precautions shown in the diagrams should on no account be omitted. Remember, the chassis is one side of the mains.

Note 2: Allen Components Ltd. have made the necessary centre tap arrangements on the line deflection coils, so that the numbers 1.2/7.3 shown in last month's circuit will now read 2.7.

Better results have now been achieved by taking the connection marked "C" on the CRT (last month's issue) to No. 7 on the line output transformer through a 470 kΩ 1W resistor, decoupled with a 0.1 µF condenser,

750V wkg., to chassis. This raises the HT on the CRT second grid to 350V, as against the previous 250V, with a consequent improvement in the operating conditions of the CRT.

Who's Next?

"Getting out a magazine is fun, but it's no picnic.

"If we print jokes, people say we are silly. If we don't they say we are too serious.

"If we clip things from other magazines, we are too lazy to write them ourselves. If we don't we are too fond of our own stuff.

"If we don't print contributions, we don't appreciate true genius. If we do print them, the page is filled with junk.

"Now, like as not, someone will say we swiped this from some other magazine. We did!"

(From the "Model Engineer" who, in turn, extracted it from "The N.Z. Model Railway Journal.")

THAT PROFESSIONAL FINISH

by A. W. WOOD, B.Sc.

Many otherwise excellent pieces of home-built gear are immediately stamped as an amateur product by the lack of a suitable finish to the bare metal. The purpose of this article is to show how a really beautiful finish can be given to any equipment, to list the necessary brushes and paint, and to enable pitfalls to be avoided. All the tips given here were obtained by experience in finishing a grid dip oscillator and a 19" power pack panel. These are both finished in a glossy grey cellulose paint. This is the type of paint used for spraying on cars, but this particular brand, Brushing Belco, is suitable for brushing on to the surface, so eliminating the necessity for spraying equipment.

The procedure is to thoroughly clean the metal, apply a primer coat, then an undercoat followed by several coats of the glossy finish. The job is then smoothed and polished. The final result is well worth all the trouble involved.

Cleaning The Metal

The directions on the tin state "Clean with turpentine substitute, etc." This is not enough. The surface must be cleaned until it is bright by means of emery cloth, or glass-paper, so that all grease and any oxide film is removed. Then clean with turpentine or the recommended alternatives, and wipe dry with a clean rag. Now apply the primer.

The Primer

A $\frac{1}{4}$ pint tin will suffice for several pieces of equipment, and a $\frac{3}{8}$ " or 1" brush will be sufficiently large. If the metal surface is flat, lay it in a horizontal plane, supported by small blocks of wood over some sheets of newspaper. The purpose of this is to ensure that the paint, which will run through any holes to a certain extent, will not stick the newspaper to the back of the panel. It is, of course, necessary that all holes and cut-outs be made before the finishing process is started. Also, the term "panel" covers whatever piece of equipment is being cellulosed. Application of the primer is not a tricky

business, and the only point to be watched is that it is not laid on too thickly. If necessary, it can be thinned by turpentine substitute. Leave the panel to dry in a warm, dry atmosphere for at least 16 hours. Clean the brush with turps substitute and stand in a jam jar of water so that the bristles are kept partly immersed.

When the panel has dried, emery paper the surface to smooth out any humps. If the paint was too thick, the humps may cause too much unevenness to be removed without wearing through to the bare metal. If this should happen, apply more primer to these places or, if required, over the whole of the surface.

The Undercoat

Next, the undercoat is applied and, again, a $\frac{1}{4}$ pint will be enough. The same brush which was used for the primer can be employed again. After use it should be cleaned as before and put into water. There is nothing tricky about the undercoat, either, as both the primer and undercoat are turps based paints. Once again, at least 16 hours should elapse before smoothing with emery cloth.

Finishing Coats

The brush for the glossy finish should be of good quality and have soft bristles. The size will depend upon the subject—for a large panel, a 2" brush will be necessary, but for a smaller article a small, bushy brush is best.

A $\frac{1}{2}$ pint tin of Light Grey Cellulose is the most suitable size. The paint should be applied with a full brush, using strokes in one direction only, parallel to the shorter edge of the panel.

Do not brush over a part which you have just painted. If there are any "runs," or brush marks, leave them alone; they will smooth out. The reasons for the provisions above are that:

(a) The cellulose dries quickly, so that strips must be applied before the previous strip dries and leaves a noticeable edge.

(b) The action of cellulose upon a previous coat is a very rapid volatilising one. With ordinary paints, the second coat serves to strengthen the first one, but with cellulose, no matter how long the first coat has been on, unless the next coat is applied quickly, and without over-brushing, it will dissolve some of the previous coat. The net result is that many small impurities are visible when the paint dries.

Put on several coats of this glossy finish, smoothing each coat after drying before applying the next. Do not attempt to obtain an absolutely flawless finish by the application of the cellulose alone, because you will not succeed.

The next step is to obtain some "water" paper, or silicon of carbide paper as it is properly termed. This can be purchased from paint dealers or ironmongers for 5d. per sheet, and consists of silicon carbide particles on a waterproof backing. The degree of fineness is indicated by the number on the back of the sheet, the higher numbers indicating finer grades. The two used by the writer were Nos. 280 and 400.

Cut a strip from the coarser sheet to go around a normal sandpaper block, and have a shallow dish of water at hand. Dip the block in the water, and rub evenly over the whole surface of the panel. Use plenty of water. Repeat with the finer paper.

This procedure will, of course, have removed the gloss from the cellulose, but this can be remedied very simply by the application of Brasso. A superior finish can be obtained by the use of a commercial rubbing compound, or by a car polish, which consists essentially of a superfine abrasive.

When polishing, rub in a spiral, working out to the edges. A perfectly good finish can be obtained with Brasso, or other metal polish, if it is not thought worth the expense of obtaining a special polish.

By the time you have finished, you should be able to see your face reflected in the panel. The brush which was used for the cellulose should be cleaned with cellulose thinners, and stood in water. Do not attempt to use this brush for any other colour, as it is impossible to remove all traces of the grey and a streaky finish would result.

Note that the abrasive paper which was used for the final rubbing down can be used to advantage on the previous coats where emery cloth was mentioned. In this case, a coarser grade must be employed, and rubbed dry and not with water. A proprietary brand of this paper is known as "wet or dry."

In conclusion, a finish can be obtained in this way which is superior to commercial stove enamelled finishes, and no one need have any fears about attempting it, if the precautions listed above are taken.

TRADE REVIEW

BURGOYNE TAPE TABLE

(Mail Order Supply Co., The Radio Centre,
33 Tottenham Court Road, London, W.1.)

The Burgoyne Tape Table is a precision made deck retailing at £16. 10. 0. It is also available on hire purchase terms of £6. 10. 0 deposit and 12 monthly payments of £1.

The table employs three motors of a type having negligible stray magnetic fields. The capstan is directly coupled to a heavy balanced flywheel, which is driven by a motor through a flexible system allowing the flywheel inertia to maintain a constant tape speed. Fast forward and rewind facilities are available, at a speed of less than a minute for a full spool of 1,200-ft. Pressure pads are used to ensure constant intimate contact between tape and heads, and the latter are set in a single unit to ensure perfect alignment.

Main control is by a pinch roller fitted with a small knob. As this roller is withdrawn, the pressure pads are automatically released, brakes are applied to the tape spools,

and the motors are switched off. For fast forward or rewind, the tape is lifted clear of the heads and capstan and the selector switch set to the desired position. Closing up the pinch roller starts the mechanism.

The tape speed is $7\frac{1}{2}$ " per second, and, since the heads fitted are half-track, a running time of one hour is possible are of a 1,200-ft. reel of tape. The heads are of the high impedance type and are suitable for capacity feed into the tape modulator and direct feed into the playback pre-amplifier. A frequency response of up to 9 kc/s is possible with tapes such as Scotch Boy, etc., and a suitable amplifier.

The table measures $16\frac{1}{2}" \times 11\frac{1}{2}"$. The maximum projection measurements are $1\frac{1}{2}"$ above, and $4"$ below the table. The finish is hammered stoved brown enamel.

RADIO MISCELLANY

CENTRE TAP talks about

CLUB MAGS — JUNK HUNT — PRICES

Since my recent notes and suggestions regarding Club Magazines and News Sheets, I have been reading copies of those received with much interest. A number, too, have come to light, apart from those of which specimen copies have been received. The biggest, both in the number of pages and circulation, is "Monitor," the organ of the very lively ISWL, but there are also many creditable efforts by local clubs with memberships around the fifty mark. Even these are not only self-supporting, but make a small profit to contribute to the general funds of the group. Sixpence per copy is the usual price.

Generally speaking, the reproduction is good all the way round, but occasional lapses in spelling appear—i.e., artical, volunter etc. The most general weakness is absence of bold headings and the rareness of illustrations. Where are the amateur cartoonists? Pages of typescript look dull unless the matter is attractively displayed, and mere typewritten capitals alone need thoughtful planning to enliven a page. Special announcements, etc., are better boxed (set out in a lined border). One magazine failed to do this in an obituary notice, where an extra bold black border should be used. More attention could well be given to the reporting of current club events and local affairs.

Despite these minor points, the general production standard is extremely good, but without exception the amateur editors make urgent appeals for more material from their fellow members, who universally seem reluctant to put pen to paper. I am sure that with mutual co-operation this aspect could be materially improved, so I am putting forward a tentative plan in the hope that it will ease the lots of the harassed editors.

A Central Bureau

Briefly, the idea resolves itself around a central pool of News Sheets, with each editor submitting a small batch of copies of his magazine for distribution to other amateur editors. In return he will receive his quota of copies of other clubs' efforts, and from

these he will be entitled to reproduce any article, or digest of it, which he feels may be of interest to his club members. Permission to reproduce would not have to be specifically sought, as membership of the Bureau would be taken as tacit consent although, naturally, acknowledgment to the source and to the writer would be made.

Incidentally, I discovered that an Amateur Magazine Association once did exist, and it struck me that such an organisation could well serve as the central pool for such a scheme. However, a letter to the last known officer of that association has failed to produce a reply, so it seems there is no other alternative, if the plan finds general favour, than to get the scheme started independently. Perhaps a volunteer organiser will come forward until such time as an elected manager can be appointed.

The pool would be run on the lines of a QSL Bureau, a number of stamped self-addressed wrappers being sent in lieu of the usual envelopes.

It seems probable that a scheme on these lines would provide the stimulus to make many club magazines brighter and even more readable, and may encourage contributors who at present feel that the effort of making a contribution is scarcely worth while when the result is seen by so limited a number of readers.

With sufficient support it may be possible to get someone to donate an annual award for the best magazine standard maintained throughout a given period, points being allocated for reproduction, layout and material interest. The size of the club and the best use of the contents/paper-size ratio would be taken into consideration. An award to the writer of the article, irrespective of its length, which is reproduced in the greatest number of different magazines might also be arranged. Amateur writers and others who have no local club magazine might be induced to send contributions to the central bureau, where they would be available for

"Knocking 'em in the Edgware Road"

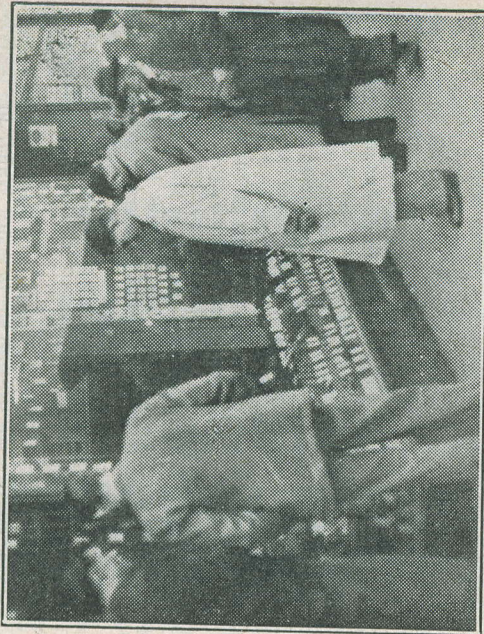

Amateur editors and others who are interested are invited to send their views and suggestions as soon as possible, even if it is merely a postcard promising support.

Junk Hunt

I recently had a radio-minded friend from Scotland staying with me for a few days, and he was, of course, intent on spending the Saturday on touring the Surplus Shops to look over the diminishing number of bargains. Most provincial readers know the London radio shops pretty well, and make a point of visiting them whenever they come to town—and from further afield than the provinces, for that matter. I remember one continental amateur who had to go to the north of England on behalf of his firm, to see a demonstration of some new mining equipment. On his way back he had a few hours to spare, which he decided to spend in London. It was his first visit, and he was met at King's Cross by an English friend who mentally planned a lightning tour of the usual sights, Parliament, The Abbey, St. Paul's, etc., leaving the visitor to choose which to include and which to cut out. Upon his arrival, he duly asked the continental amateur which of the many places of interest he most wished to see, and he was amazed to receive the reply, "The Junk shops."

It took the friend (who knew nothing of radio) some minutes to guess what he meant and, even when at last it dawned on him,

he hadn't the faintest idea where to look for them. Fortunately, a taxi-driver knew better and took them to Lisle Street, where our English friend waited patiently while the visitor browsed over battered ex-WD gear. No doubt he is still marvelling at the strange ways of foreigners!

Lisle Street was the first point of call for my Scottish visitor and I. We poked around for a long time, but bought nothing. Lisle Street must be losing its grip, for when we moved on to the Edgware Road area we both indulged in an orgy of junk buying. I only wanted a few bits and pieces, myself, and to equalise the load I found myself carrying nearly half of his. He bought an enormous half-stripped chassis for a few shillings, just for the sake of the meter, and as he was already fully loaded I had no choice but to offer to help carry it. If I had taken a screwdriver and pliers I might have whipped off a few of the components and shed them on the wayside. In fact, at the time I fervently wished I had. Ex-WD chassis are invariably awkward shapes, and this particular one would have left Euclid simply dizzy.

It was nearing dusk when we got back, hot and dirty, and looking like a couple of itinerant tinkers carrying our stock-in-trade. We were both too ashamed to be seen in our select suburban district in such a state, loaded up as we were like beachcombers after a shipwreck. We hung around taking in a little refreshment, to sneak in after it was dark.

Even then, a horrible clanking of ironmongery heralded our return, which in the quiet of the evening seemed worse than ever.

Among the bits and pieces were some lengths of dural tubing, acquired with the object of making a mike carrier and boom, as I have been lured back into making amateur talkies. You can imagine the difficulty we had in manoeuvring it through the Saturday shopping crowds. At one time I had a pram hooked on the back end and, in a desperate effort to disengage the front end, I prodded some portly character in the corporation. Perhaps it was his injured feelings or punctured dignity that stimulated his eloquence in telling what we were and what we looked like. No doubt, too, it was his description ringing in our ears that caused us to delay our homecoming until after dark. Happily the dural was undamaged. Nowadays it costs 1/3d. a foot! Back in 1948 it was so plentiful that I built a ten metre Plumbers' Delight and had a whole lot left over out of five bob's worth. I suppose the demand for TV aerials has long since swallowed up the surplus. Anyway, the mike boom is a great success and all we want now is a crane. So far I haven't found any on the junk market.

Whistle While you Work

Thinking of mikes reminds me of just how much whistling into them one hears on the amateur bands. The majority of amateurs all over the world would seem to use no other form of modulation check than a meter in the mod. output stage. Then if the needle kicks up to show about double the plate current as they whistle, the modulation

percentage is assumed to be about right. I use a 'scope, myself, and consequently feel most virtuous about it!

It reminds me of an incident which occurred back in about 1930, when the B.B.C. arranged a series of programmes in which people described their daily work. One man taking part in the series felt at the last moment that his carefully rehearsed script needed brightening up. Unknown to the worthy Corporation, he decided to embellish it with a few sound effects. No doubt when he tried it out before his admiring family they warmly approved the additions.

One of the impromptu effects was a whistle, intended to give atmosphere when he came to the part of the mail train being signalled off. Before anyone could stop him, he whipped a whistle out of his breast pocket and let out a long shrill blast right into the microphone.

You can well imagine the effect the sudden surge of current produced in the transmitter. As far as I could discover no one bothered to enquire just what other effects he had up his sleeve. That one put the Daventry transmitter off the air for nearly an hour while the Engineers fitted replacements, and it cost the B.B.C. over £300. Anyway, it was good work by the Engineers to clear up the shattered transmitter stages so quickly. I have always had a warm regard for the Engineering side, despite my impatience with their top heavy administrative and programme staffs. Readers may well recall the occasion a few months before the War when the Droitwich aerial was struck by lightning and burnt up. The Daventry aerial, which had then been standing idle for about five years, was quickly pressed into service and radiation continued. The Engineers worked on the Droitwich aerial all night with the aid of searchlights, and I believe it was back into service the next day. When your own aerial comes adrift on a dark and dirty night, it will make it just a little easier if you remember the Droitwich one has a height of 700 feet.

Gale Warning

In a small fishing village where I spend an occasional week-end, there lives an old boy who has a remarkable local reputation for the accuracy of his weather forecasts. In fact, it is said the local farmers consult him regularly around seedtime and harvest, and visitors planning an outing set great store by his prognostications.

To soothe the fears of a rather nervous XYL before hiring a boat we sought his reassurance as to the chance of the calm spell continuing. You can imagine our consternation when he replied "Can't rightly say. My wireless set's broke down."

QUERY CORNER

A "Radio Constructor" Service for Readers

Dummy Aerial

In various articles on the design of signal generators, I have noticed that mention is made of a dummy aerial. What is this device used for, and can one be easily constructed?

E. Unwin, Brighton.

When aligning a radio receiver with the aid of a signal generator, it is most important that the receiver is operated under similar conditions to those which exist when it is working normally with an aerial connected. If this condition is not satisfied, it is possible for the alignment and also the sensitivity measurements to appear quite satisfactory on the test bench, but as soon as the external aerial is connected the conditions are very different. The reason for this should be apparent if we consider the case of a standard broadcast receiver being aligned with the aid of a signal generator which has a low impedance output. When the generator is connected to the aerial socket of the receiver, its output impedance will shunt the coupling coil on the first tuned circuit within the set. The most obvious effect of this will be that the tuning of the aerial transformer will be very flat, and it will be impossible to determine the optimum setting of the trimmer. On the other hand, it is impracticable to arrange the output of the generator to be very high because of the difficulty of keeping a check on the output voltage, which would, of course, vary according to the output impedance. Such variations would render the taking of sensitivity measurements an impossible task without the aid of additional equipment.

Thus it is that the arrangement which is generally employed involves the use of a generator having a low impedance output in conjunction with a dummy aerial. This latter is a device which has a loading effect on the receiver which is similar to that of the normal aerial. Also, because the dummy aerial is connected in the lead between the signal generator and the receiver it prevents the generator from loading the aerial circuit within the receiver and thus introducing the difficulties which have already been discussed. The dummy aerial which is suitable for use on the

medium and long wave ranges consists simply of a 200 pF capacitor, a 25μH inductor and a 25 ohm resistor, all connected in series and included in the live side of the generator output lead. Those who do not wish to wind their own coil will be interested to know that the Wearite PO6 coil may be successfully used for the purpose. The dummy aerial is conveniently constructed in a small metal box with flying input and output leads, so that it may be easily connected between the generator and the receiver. Most short wave receivers are designed to have a low impedance input so that a dummy aerial is not necessary, the generator feeding directly into the set.

Beam Blanking

About a year ago I completed an oscilloscope using a transistor oscillator as the time base. I have found the instrument extremely useful and satisfactory but for one factor, when the time base is operating on the higher frequency ranges the fly-back line on the screen becomes particularly noticeable. This effect can be rather distracting when looking for certain kinds

QUERY CORNER

"Rules"

- (1) A nominal fee of 2/6 will be made for each query.
- (2) Queries on any subject relating to technical radio or electrical matters will be accepted, though it will not be possible to provide complete circuit diagrams for the more complex receivers, transmitters and the like.
- (3) Complete circuits of equipment may be submitted to us before construction is commenced. This will ensure that component values are correct and that the circuit is theoretically sound.
- (4) All queries will receive critical scrutiny and replies will be as comprehensive as possible.
- (5) Correspondence to be addressed to "Query Corner," Radio Constructor, 57 Maida Vale, Paddington, London, W.9.
- (6) A selection of those queries with a more general interest will be reproduced in these pages each month.

The Editor invites

articles from readers, of a nature suitable for inclusion in this magazine. Articles submitted for publication should preferably be typewritten, but ordinary writing is acceptable if clearly legible. In any case, double spacing should be used, to allow room for any necessary corrections. Drawings need not be elaborately finished, as they will usually be redrawn by our draughtsmen, but details should be clear. Photographs should preferably be large (half-plate) but in any case the focus must be good. Much useful advice to prospective writers is given in our "Hints for Article Writers," which will be sent free on request.

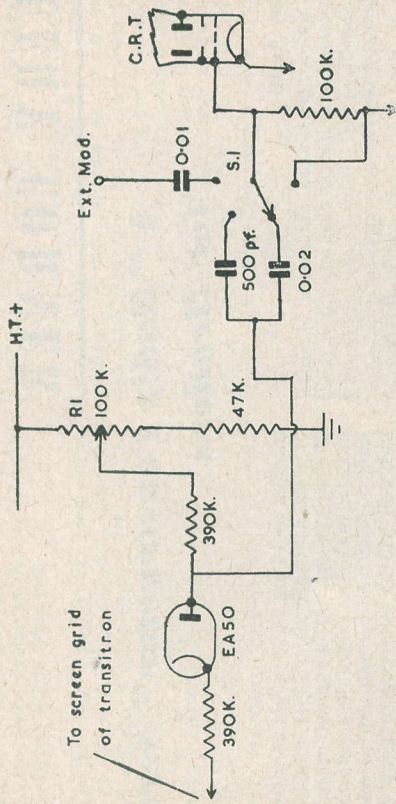

C 582

Fig. 1: The additional components used in the beam blanking circuit are shown in the diagram. R1 is a pre-set linear potentiometer.

of phenomena. Can you recommend a simple circuit which will enable me to blank out this flyback line?

D. Underwood, Putney.

When designing a time base to operate over a wide range of frequencies it is difficult to maintain a fast flyback time when working on the upper ranges. This effect is particularly marked when a transistor type of oscillator is employed in the time base, and although this type of oscillator is highly satisfactory for use in home built oscilloscopes it does suffer this defect. When working above about 10 kc/s the flyback is often sufficiently long to take several cycles of the signal under examination with the result that the flyback stroke has a tendency to partially obscure the forward or working stroke. This defect can be easily overcome in most oscilloscopes by arranging that the C.R. tube scanning beam is cut off during the flyback period. It is fortunate that the waveform found at the screen grid of a transistor has a negative going flyback pulse which can be applied to the grid of the tube to extinguish the beam during the flyback period. However, as the voltage at the screen does not remain constant during the working stroke, it must undergo some treatment to prevent it altering the trace intensity. This treatment is obtained by means of a simple diode circuit such as is shown in Figure 1. The anode potential of the diode is adjusted by means of the pre-set control R1 so that it does not conduct during the working stroke, but passes the negative going pulse which occurs during the flyback period to the grid of the tube.

RUFUS—THE RADIO CONSTRUCTOR

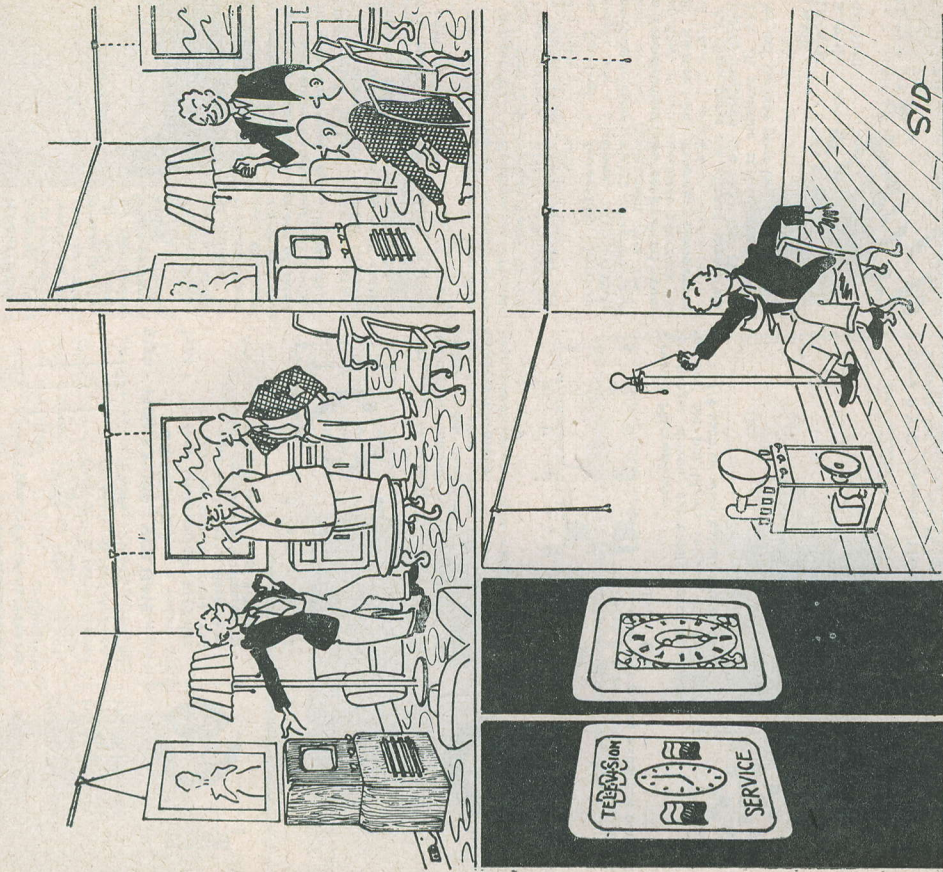

NOTICES

THE CONTENTS of this magazine are strictly copyright and may not be reproduced without obtaining prior permission from the Editor. Opinions expressed by contributors are not necessarily those of the Editor or proprietors.

THE EDITOR invites original contributions on construction of radio subjects. All material used will be paid for. Articles should be typewritten, and photographs should be clear and sharp. Diagrams need not be large or perfectly drawn, as our draughtsmen will redraw in most cases, but relevant information should be included. All Miss must be accompanied by a stamped addressed envelope for reply or return. Each item must bear the sender's name and address.

TRADE NEWS. Manufacturers, publishers, etc., are invited to submit samples or information of new products for review in this section.

ALL CORRESPONDENCE should be addressed to Radio Constructor, 57, Maida Vale, Paddington, London, W.9. Telephone: CUN. 6518.

ELPREQ PAGES

SPECIAL PERSONAL SET OFFER.



Resulting from the change-over of a famous manufacturer to important work, we are able to offer practically all the parts for this really neat personal radio illustrated. The most important thing of course is the cabinet and for this we can offer a complete kit of parts, which includes cream plastic lid, base and escutcheon cracked metal body and all accessories such as knobs, hinges, lid arm, and clips etc. Price 22/6. Cabinet size 7" x 4" x 3 1/4".

Other items available are: **Metal Chassis.** Five part assembly comprises the main chassis and sections for holding the batteries and the loudspeaker. Price 4/6. Ditto with four BVG valve holders already riveted in their correct positions. Price 7/-.
Frame Aerial Cover 1/6.
Frame Aerial 3/6.
Oscillator Coil 3/6.
I.F. Transformers, BVG Amphemol Wearite Midget Type 400B 15/- each.
Volume Control 1/-
Speaker Midget 3/6.
Speaker Midget, Plessey alignment data 2/6.
Battery Stud 5/-
On/Off Switch lid operated 1/6.
Note: All these parts are offered separately. Valves required are IR5, IS5 IT4, or 3V4, all available at low prices, send for our current valve list.

Resistors Miscellaneous Total 11 4/-
Condensers Miscellaneous Total 10 4/6.
Wearite Midget Type 400B 15/- each.
Volume Control 1/-
Speaker Midget 3/6.
Speaker Midget, Plessey alignment data 2/6.
Battery Stud 5/-
On/Off Switch lid operated 1/6.
Note: All these parts are offered separately. Valves required are IR5, IS5 IT4, or 3V4, all available at low prices, send for our current valve list.

BLANK CHASSIS

18 S.W.G. Aluminium	5/-
7 x 3 1/2 x 2	5/9
9 1/2 x 4 1/2 x 2 1/4	7/-
10 x 6 x 2 1/4	6/6
10 x 5 1/2 x 2 1/4	7/3
12 x 6 x 3	7/3
12 x 5 x 2 1/4	7/6
14 x 6 x 2 1/4	8/3
14 x 10 x 3	8/6
16 x 8 x 3	8/3
16 x 12 x 3	10/-
20 x 10 x 3	10/6



SHEET PAXOLIN

Invaluable for when you are experimenting.
 Size 6in. x 6in., 1/-
 Size 12in. x 8in., 2/-
 Size 12in. x 12in., 3/5.
 Size 24in. x 12in., 6/-

SUB-MINIATURE COMPONENTS.

Highly suitable for deaf aids, flying control, or other midget electronic equipment. All ex-unused equipment.

Sub-miniature valves—wire ended.

Type.	Sub. Heater Current.	Suitability	Price.
CV385	1.4v. 25ma.	Output Pentode	5/9
CV387	1.4v. 25ma.	Output Pentode	5/9
CV2107	0.75v. 25ma.	HF/AF Pentode	4/9
CV443	0.75v. 25ma.	HF/AF Pentode	4/9
CV386	0.75v. 25ma.	HF/AF Pentode	4/9

SUB MINIATURE VOLUME CONTROLS.

Type 1 3 meg with switch probably the smallest control made, can be used with finger plate removed, control being effected by an 8 B.A. screw. Price 3/9 each.

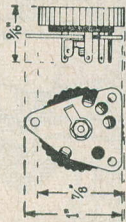

Type 2.

Again 3 meg with switch, this one is the same size but cannot be used without the finger plate. Price 3/3.



Output Matching Transformers.

Ratio approximately 10 to 1 intended to match output of CV385 or CV387 into crystal earpiece. Price 3/6.

High sensitivity very light weight complete with 1 yard of special P.V.C. covered tinsel flex and slide contacts. Price 8/6.

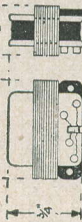

Ditto but without flex or contact slide—note this makes excellent microphone. Price 6/6.

Crystal Microphone. Diaphragm driven, extremely sensitive, made for deaf aid but highly suitable for recorder work. 7/9 each or with bakelite case 14/6.



HEARING AID CASE.

Bakelite with lapel clip. Also makes an excellent case for the above crystal microphone, which would be equal to any hand crystal microphone being advertised at 5 gns. Price 7/9.

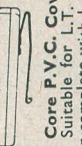

4 Core P.V.C. Covered Tinsel Flex Leads.

Suitable for L.T. and H.T.—length approximately 1 yard. Price 1/3, or complete with L.T. and H.T. battery plug 3/9.

WIRE WELDER.

Bakelite covered wire welder for rapid y joining copper or alloy wires of between 28 and 48 S.W.G. First pressure of the trigger brings two anvils together to hold the wires. Cleaning is seldom necessary and the process requires no fusing agent.
 Step down transformer or other low voltage source is required but a resistance in the hand-plate limits the maximum current. Special price only 9/6 each.

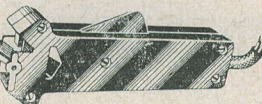

PERSONAL SET FOR £3. 10s. 0d.

Complete in cabinet as illustrated, this is a 3 Acorn Valve, T.R.F. Circuit which gives quite good results using a short throw-out aerial. Total cost of everything except batteries is 70/-, but it is probable you have some of the parts, so in the first place send 17/3 for cabinet which includes instructions free, or 1/6 for instructions only.
 Note this cabinet is of the following internal dimensions: 6 1/2" high x 5 3/4" wide x 3" deep, which makes it suitable for the P.W. Mini-Four and other personal sets.

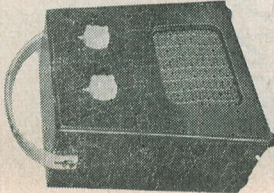

SPECIAL FOR CONSTRUCTORS.

Beautifully made wooden cabinet, complete with punched metal chassis, glass dial ports and clips. 3 knobs and wooden back.
 Why not build a few receivers during the summer months, we can supply all the parts for either super-het or T.R.F.?

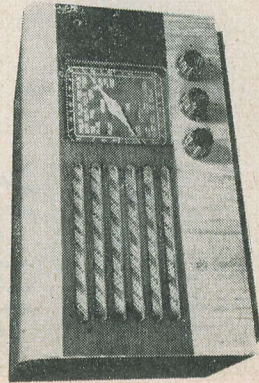

Price of parcel as above, 29/6, plus 2/6 postage and insurance.

FOR ONE MONTH ONLY ONLY £6. 19. 6.

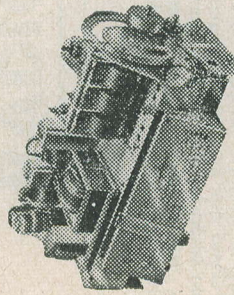

7 VALVE, 5 WAVEBAND RADIO CHASSIS.

A famous set by a famous manufacturer. Undoubtedly a serious listener's receiver. Among many special features are a H.F. stage and tuning indicator. Tuned up to 11 metre band. We have a few left, less valves and power packs, otherwise in good condition they definitely have never been used. While stocks last and for this month only can have one at £6. 19. 6, plus carriage and packing 15/-, H.P. Terms: £2. 6. 6. deposit and nine monthly payments of 12/-.

THE TELETRACER.

This booklet! Free. Send 3d. stamp to-day.



With the Teletracer signals can be followed through the T.V. to the tube or Loud-speaker. Similarly, powerful indications can be obtained in and around the sync. separator and time base sections. The Teletracer uses 5 valves and speaker and operates entirely from A.C. and D.C. mains. Send for a free copy of the instruction manual or better still save time by sending £6 10/-, plus 7/6 post and insurance for the complete outfit.

5 AMP ADJUSTABLE THERMOSTAT.
 Useful for the control of appliances such as convectors, gluepots, Vulcanisers, hot plates, etc. This thermostat has a temperature range of between 50-550 deg. F. and is fitted with heavy (5 amp. A.C.) silver contacts and a patented arc damping device. Price 14/6. 1 Amp model 3/6.



FLEXIBLE COUPLINGS.



These are sometimes known as bellows couplings because they will extend as well as bend. They are ideal for joining shafts which are out of alignment and for slug tuning controls, where the core has to come in and out. Price 1/9 each.

ELECTRICAL BARGAINS.

Hicraft 5-amp Surface Switch, bakelite, 1/6 each, 15/- doz.



5-amp 3-pin shuttered socket, brown bakelite, 1/3 each, 12/- doz.



Orders by post are dealt with by our RUISLIP depot. To avoid delay address to:—E.P.E. Ltd., Dept. 3, Windmill Hill, Ruislip, Middlesex.

Except for heavy and delicate items where carriage charge is specified, orders over £2 are post free, under £2 add reasonable amount bearing in mind a 15 lb. parcel costs 2/-. Postable items can be sent C.O.D. additional charge approx. 2/6. List 6d.
 Early closing, Wednesday—Ruislip, Saturday—City.



PRECISION EQUIPMENT

WINDMILL HILL, RUISLIP MANOR, MIDDLESEX, AND AT 152-153, FLEET STREET, LONDON, E.C.4

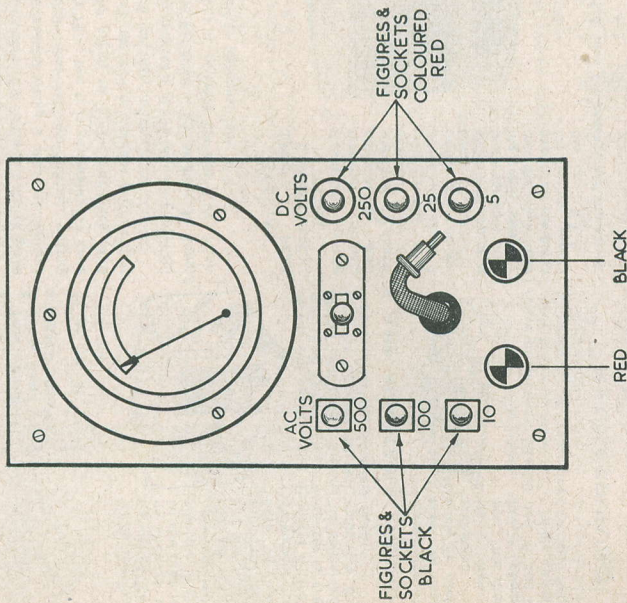

SCALE FIGURES TYPED ON WHITE PAPER & COVERED WITH ADHESIVE CELLOPHANE

C679

The following is a brief description of a multi-range AC/DC voltmeter, the construction of which was based on an ex-WD 0-1 mA meter.

The two diagrams will be largely self-explanatory, but a few notes may be of interest.

First, regarding the movement itself, this should have a finely divided scale. That used by the writer had five main divisions, each of these being sub-divided into ten.

The resistors should be of guaranteed accuracy to within a small percentage of the rated value: ± 1 per cent. is ideal and not too expensive. They should also err on the large size as regards wattage rating, in the interests of long term stability: 1W rating is ample.

The switch used was a Dewar type, simply because this was available, but any suitable DPDT switch could be employed. The

biased type of switch, where the lever is normally "off" unless pressed over, is a particularly good one to use as one gets into the habit of checking the meter range and connections before taking a reading.

A rotary stud switch could be used for the different voltage ranges, but it was considered that the insertion of the wand plug into the appropriate socket was less conducive to error, thus safeguarding the meter. Incidentally, it is much cheaper.

Great care is necessary when soldering the rectifier connections, as the efficiency of this component will be seriously impaired if it is at all overheated.

Care should also be exercised regarding insulation, as voltages up to 500 may be applied across the input terminals.

If the work is carefully carried out, an accurate and extremely useful instrument will be obtained for a very low cost.

A MULTI-RANGE AC/DC VOLT-METER

by

S. D. DEAN

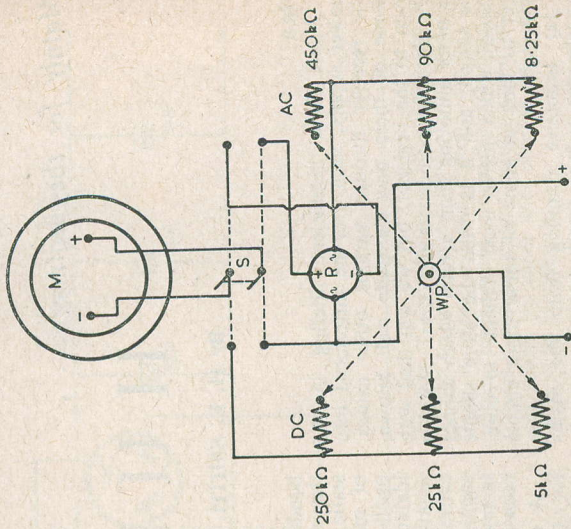

Circuit of the Multi-Range AC/DC Voltmeter, with values.

C678

RADIO BOOKS

VALVE TECHNIQUE (RSGB) -	- 3/9	WORLD RADIO VALVE HANDBOOK (O. Johansen) -	- 11/9
RECEIVERS (RSGB) -	- 3/9	WORLD RADIO HANDBOOK (O. Johansen) -	- 8/9
TELEVISION INTERFERENCE (RSGB) -	- 2/3	HOW TO LISTEN TO THE WORLD (O. Johansen) -	- 1/11
SIMPLE TRANSMITTING EQUIPMENT (RSGB) -	- 2/3	INEXPENSIVE TELEVISION (ASWP Ltd.) -	- 2/8
SERVICE VALVE EQUIVALENTS (RSGB) -	- 1/3	TV FAULT FINDING (ASWP Ltd.) -	- 5/3
RSGB CALL BOOK (ASWP Ltd.) -	- 3/9		
BASIC SUPERHET (ASWP Ltd.) -	- 1/2		

Above prices inclusive of postage, etc.

CLIFTON PRESS

Lyon Court, 57, Maida Vale, London, W.9. Tel. CUN 6579

Mainly for the Beginner . . .

HUM

By H. E. SMITH, G6UH

Hum

Apart from insufficient filtering in the power supply, hum may be introduced into the receiver through various other causes. Some of these may be quite well known, even to the beginner, but we will deal with the more common causes and cures. Nothing is more annoying than a hum which cannot be traced, and it is often the more simple causes which prove most difficult to cure. Let us look at some of these more simple ones:—

- (a) Inductive coupling from the mains transformer or iron cored choke to a neighbouring iron cored transformer or even an RF choke or tuning coil.
- (b) The presence of a magnetic field near to a valve.
- (c) Induction from the heater wiring to leads carrying RF or leads in any high impedance circuit (i.e., Grid and anode leads).
- (d) Long unscreened grid leads in the audio circuits.
- (e) Poor heater to cathode insulation in a valve.
- (f) Modulation Hum. This is the hum that is only present when the receiver is tuned to a carrier, and may be due to a variety of causes. Some of these are insufficient filtering, poor earthing of the receiver, badly

bonded lead-covered cable or conduit carrying the mains supply in the house, no electrostatic screen between primary and secondary of mains transformer, poor filtering of the oscillator anode HT supply. Quite a formidable list, but if attention is paid to certain points during construction, most of these causes may be ruled out. Perhaps the power supply will be a good point to start at, as in many cases this has been found to have been the root of the trouble.

A normal power supply of the type used for the average receiver and capable of delivering between 250 and 300 volts at approximately 100 mA will, if fitted with a 15 Henry choke and two 8 μ F electrolytics, produce a ripple voltage of approximately 0.1 RMS. Such a circuit is shown in Fig. 1. This will not be good enough for serious Short Wave work, especially if headphones are to be used, as the hum will be quite noticeable. The ripple voltage may be reduced to something approaching 0.05 V RMS by increasing C2 to 16 μ F. The hum will now be barely perceptible, but if a TRF receiver is to be used a threshold hum will be in evidence as the set goes into oscillation.

A far better arrangement is shown in Fig. 2. As will be seen, two 15 Henry chokes are used in conjunction with three 8 μ F electrolytics. The ripple voltage drops to some-

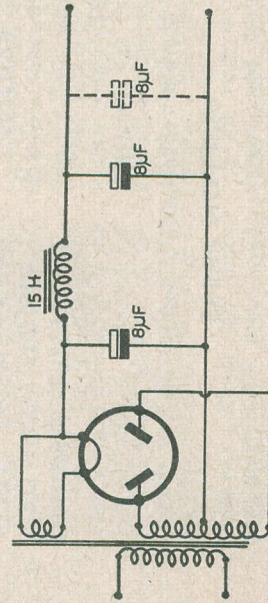
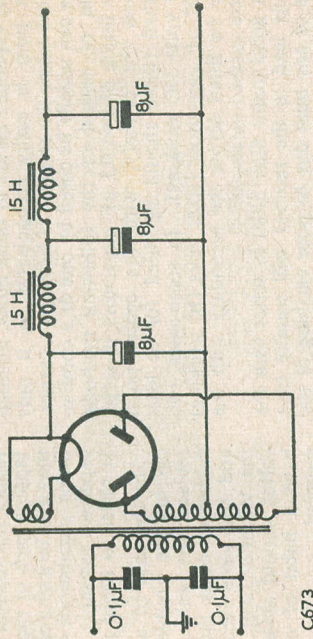

Fig. 1: Circuit of simple power supply.

C572

Fig. 2: Double section filter (recommended for communications receiver work).



C673

thing like 0.02 RMS, and there is little chance of any hum being due to a badly filtered power supply. The two 0.1 μ F capacitors shown wired across the primary of the mains transformer in Fig. 2 are to prevent modulation hum.

Chassis Wiring

It is most important that the heater leads should always be twisted together, and wherever possible taken along the bend of the chassis and tucked well into the corner well clear of any other leads carrying RF or grid or anode feeds. Do not rely on a single connection for the earthed heater, earth it at the start and finish of the run.

Take all decoupling capacitors and cathode resistors direct to chassis and never to the earthed heater tag of the valveholder. Where any grid lead exceeds an inch or two, always use a length of screened lead with the screening earthed to the chassis by the shortest route. In the case of grid leads carrying RF, the fitting of a length of screened lead may cause unwanted capacity, and it is always better to completely screen the RF compartment from

the rest of the chassis. The volume control is often an unsuspected cause of hum pick-up. Hum is often induced directly on to the carbon track from a nearby transformer. Choose a volume control with a metal back, and solder an earth wire directly to it and earth it to the chassis.

Component Layout

The arrangement of the components on the chassis plays an important part in avoiding hum. When push-pull output stages are to be used, the driver transformer should be carefully positioned relative to the mains transformer, otherwise there will be a risk of severe hum being induced. It is a good plan to use slotted fixings for such transformers, and if any hum troubles are experienced the transformer may be partly rotated to cancel out the field. (Fig. 3).

Arrange that the RF and mixer valves are situated at the opposite end of the chassis to the mains transformer, and never use unscreened coils in any circumstance.

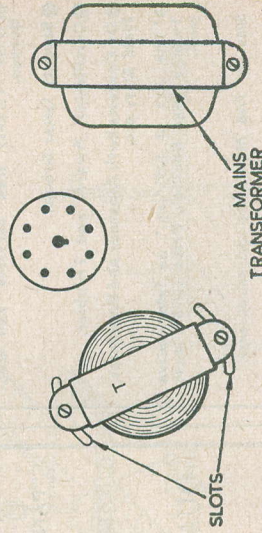

Fig. 3: Driver transformer "T" fitted to chassis in semi-circular slots to allow for rotation against field of mains transformer. The slots could be cut through 90° if necessary.

C674

Cures for Modulation Hum

As explained earlier in these notes, modulation hum is easily recognisable as it only occurs when the receiver is tuned to a carrier. This can usually be cured by one or a combination of several of the following methods. The fitting of two 0.1 μ F capacitors in series across the primary, with the centre point earthed (these should be rated for at least 750 volts DC working). In some cases, two 0.002 μ F capacitors (1000 volts DC working) may be fitted across the secondary with the centre earthed as above.

A good mains filter fitted in series with the mains lead to the receiver will usually take care of any hum due to poor earthing of the conduit or lead covering of the house mains. Cathode/Heater leakage in the mixer valve can only be cured by replacing the valve. Finally, if all else has failed, improve the filtering to the oscillator stage by adding a separate choke and capacitor, at the same time checking that the RF stage is not overloading due to failure of the AVC.

Microphony and "Motor boating"

The vibrations from the loudspeaker will sometimes set up a noise not unlike a hum.

This can usually be quickly identified by tuning the receiver off the station and lightly tapping each of the valves in turn. The gang may also be a source of trouble in this direction. Some commercial receivers have the tuning capacitor assembly mounted on rubber bushes in order to avoid this trouble.

In the case of a valve being found to be causing the trouble, the only real cure is to replace the valve. Shielding with sponge rubber or other material is a makeshift cure, and the loose electrodes which are causing the vibration will remain loose. "Suspect" valves should always be discarded, as they have a habit of misbehaving at the wrong moment.

Motorboating, or audio frequency instability, often takes on the form of a low pitched hum, and is sometimes difficult to distinguish from the hum due to poor filtering.

Adequate decoupling is the answer to this one, especially in the anode circuit of the detector or double diode triode. To avoid trouble, it is always wise to fit an electrolytic capacitor of at least 4 μ F as the anode decoupler, and use good quality capacitors for all other decoupling purposes.

A HANDY LOCATING JIG

by A. TORRANCE

C676

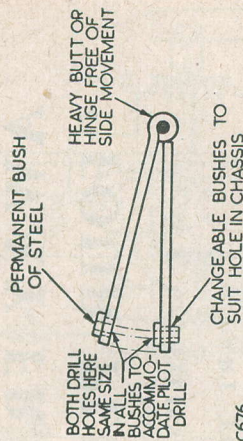

How simple awkward jobs can be, if only the right tool for the task is at hand.

Your writer, for instance, has collected them from practically every other occupation. The one to be described here was used by him when engaged on aircraft metal repairs. Such gadgets are often particularly useful at the present time, when the constructor is continually changing, modifying and redesigning ex-WD gear.

One of the "fiddling" things often found necessary is the fitting of a new front panel, which involves the location of fixing holes to match up with those already present in the existing chassis. The tool shown in the sketch is so simple, and does the job so easily, that the writer is astounded that such a thing is not available commercially. The reader

will doubtless visualise it in other forms suitable for other applications.

A word of advice regarding construction. This jig will be at its best when made of good materials. The hinge should be stoutly built, and there should be no end-play in particular. Brass could be used, but steel would be better. The top locating bush may be permanently fixed, as it takes only one size of drill which is used to make a pilot hole which is afterwards enlarged to the size required. This bush should preferably be of hardened steel. Next best is mild steel, case-hardened. The bottom bushes are interchangeable. All have the same size centre hole as is used for the top bush, but the spigots are of various diameters to suit the size holes which may be encountered on different jobs. It is, of course, essential that the upper and lower bushes be concentric, and the holes through them be in line.

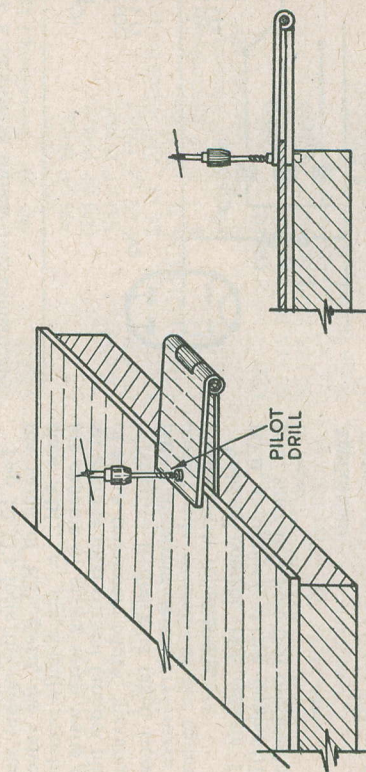

C677

introducing . . .

"PANL"

"PANL" is an air drying crackle finishing enamel, which may be brush or spray applied, no special precautions being needed.

"PANL" dries with a black crystalline gloss, and gives that professional finish to chasses, panels, etc.

"PANL" gives a new look to old equipment.

"PANL" is obtainable from your local radio parts dealer.

QUALITONE PAINTS LTD.

10-14 Mitford Rd.,
London, N. 19.



Join the . . .
**INTERNATIONAL
SHORT WAVE
LEAGUE**

H.G., 123 Sturla
Rd., CHATHAM
KENT, ENG.

Membership 10/6 per annum (U.S.A. \$1.60), including 12 issues of *Monitor*—the League journal. Associate Membership 2/6 (U.S.A. \$0.40). Both grades include free use of all Services, entry into Contests, etc.

- Over Twenty free Services and **GSL** Bureau.
- Seventy Local Groups.
- Certificates, Awards and Trophies.
- DX Contests both Amateur and Broadcast, Field Day, etc.
- 'The Art of **GSL**'ing, an informative Twenty Page Booklet, Price 1s. 0d. post paid.

Send for Free Membership details at once.

AWAY FROM THE "FOUR PLUS ONE"

by F. L. BAYLISS, A.M.I.E.E.T.

PART FOUR

Power with Economy

It is not only your writer who holds the opinion that one cannot even begin to talk about quality in a receiver, unless that receiver incorporates a push-pull output stage.

Figures talk, and whilst a single pentode invariably has a total distortion figure of between 8 per cent. and 12 per cent., two such in push-pull result in only a fraction of this—just 1 per cent. or 2 per cent.

Usually, however, push-pull output is a luxury beyond the price-range of the average receiver. It necessitates the use of more valves and a higher-rated power-pack equipment, as well as greater care in design, and on these accounts, probably, has not been favoured in the commercial field.

Your writer, however, maintains that with careful and correct design, none of these obstacles need exist—that a really first class, sensitive and powerful superheterodyne can be built that will dissipate not more than the usual 80mA of a four-plus-one, yet without an expensive power pack, and giving a full seven watts of undistorted output from the same number of valves.

Such a receiver is shown diagrammatically in Fig. 1.

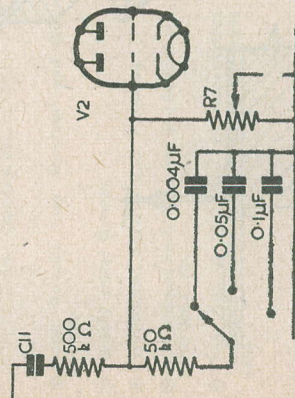

FIG. 2
A VARIABLE-BIAS-LIFT CIRCUIT C656

The Circuit

V1 is a triode-heptode, the heptode section of which functions as combined oscillator (g2-g4, and g1) and mixer.

The IF output is demodulated by a West-ector (which also provides AGC) and is then taken to the triode section of the valve, which functions as audio amplifier.

Reaction is taken from the triode anode to a supplementary winding on the IFT.

The reaction largely replaces the IF amplifier (omitted for economy's sake) and may be used to boost weak signals, as a panel control, using a reaction capacitor. Alternatively, and this is the method shown, the reaction may be preset to a convenient level by the preset capacitor C13; if the most is to be made of the receiver quality, however, the former method is preferable, since reaction will not be needed on home transmissions.

The output from V1 is taken to one grid of V2, a double-triode acting as phase splitter. To ensure a well-balanced signal, R18 and R19 should be high-stability resistors, having tolerances ± 2 per cent. of the values.

Two EL32's form the output stage. With the value of R21 given, the valves work in class AB1, i.e., are slightly over-biased, and are capable of giving seven watts output for an average total current (anodes plus screens) of 68mA (minimum 63mA, maximum 73mA).

Negative feedback is taken from the output transformer secondary—make sure the correct side is used—to the cathode of the phase-splitter input triode.

Volume control, not entirely futile with NFB, is applied at the double-triode input grid, since it is here that overloading is likely to occur.

Applications

Although it would be eminently suitable as a powerful (and delightful) household

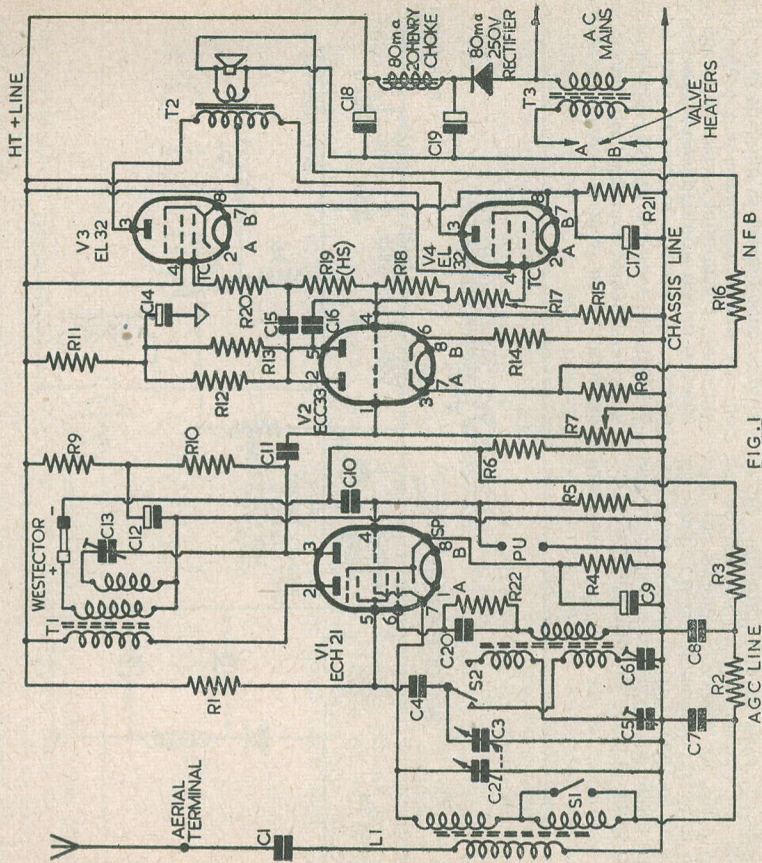

C655

- R1 33 k Ω , $\frac{1}{2}$ watt.
- R2,R3,R15,R19 220 k Ω , $\frac{1}{2}$ watt. (R19—2 per cent. High stability)
- R4 200 Ω , $\frac{1}{2}$ watt.
- R5,R6 500 k Ω , $\frac{1}{2}$ watt.
- R7 500 k Ω Potentiometer.
- R8,R14 2.2 k Ω , $\frac{1}{2}$ watt.
- R9,R11 10 k Ω , $\frac{1}{2}$ watt.
- R10,R12,R13 100 k Ω , $\frac{1}{2}$ watt.
- R16 22 k Ω , $\frac{1}{2}$ watt.
- R17,R20 1 k Ω , $\frac{1}{2}$ watt.
- R18 270 k Ω , $\frac{1}{2}$ watt. (2 per cent. High stability).
- R21 330 Ω , 2 watt.
- R22 47 k Ω , $\frac{1}{2}$ watt.
- L1 MW and LW Aerial Coil.
- L2 MW and LW Osc. Coil.
- T1 465 kc/s IF Transformer. (see text).
- T2 10 watt output Transformer (push-pull) with ratio 56 : 1, 28 : 1 each half.
- T3 200—250 volts input, 6.3V, 2A output, filament Transformer.
- V1 B8G Valveholder.
- V2 3 Inter. Octal V-Holder.
- C1 0.002 μ F Mica.
- C2,C3 500 pF Two-Gang Tuning Capacitor.
- C4 300 pF Mica.
- C5 600 pF Preset.
- C6,C13 300 pF Preset.
- C7,C8 0.02 μ F Paper.
- C9,C17 25 μ F, 25V Electrolytic.
- C10,C11,C15,C16 0.1 μ F Paper.
- C12,C14 8 + 8 μ F Electrolytic
- C18,C19 16 + 16 μ F Electrolytic 450V working, DC.
- C20 100 pF mica.
- 80 mA 20 Henry Choke.
- 80 mA 250V Selenium Rectifier.
- 3 Ω , m/c Loudspeaker.
- Type WX1 or WX2 Westector.
- V1 Mullard ECH21.
- V2 " ECC33.
- V3,V4 " EL32.

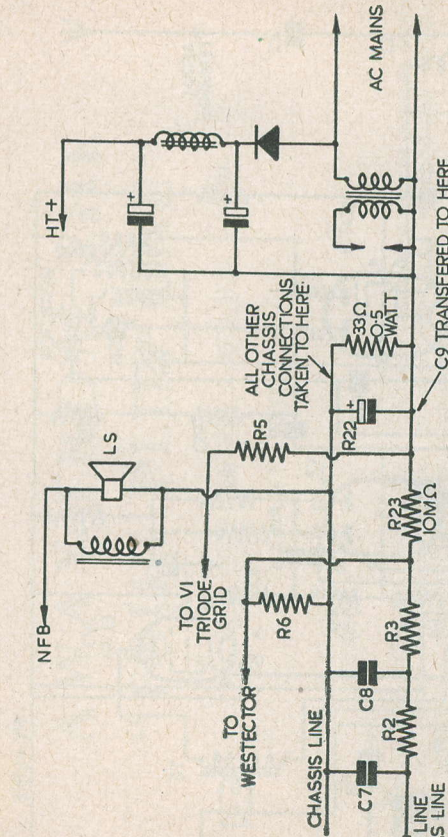

FIG. 3
METHOD OF BIASING V1 VIA R22 & R23
ALL OTHER CONNECTIONS AS FIG. 1

C657

receiver, the circuit is ideal as a radiogram unit and has been designed primarily as such. It is capable, too, of extensive modification to suit users' tastes; for instance, the EL32's triode-connected would allow one to dispense with the NFB and to introduce a "bass-lift" tone control that would compensate for the low-note attenuation of gramophone records. Such an arrangement is shown in Fig. 2. Connect the EL32 screen-grid to the anode via a 1000Ω, ½ watt resistor, and include a 500Ω, ½ watt stabilizing resistor in each anode lead, between the anode and the transformer connection.

Remember, however, that connected thus the output from the EL32's is halved, i.e., the original seven watts becomes only about three watts.

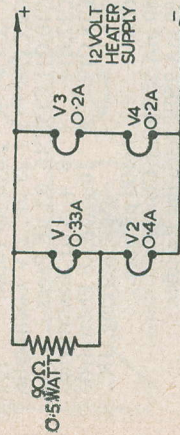

FIG. 4
ARRANGEMENT OF VALVE HEATERS
FOR 12 VOLT SUPPLY

C658

running off vibrator supplies, as a car radio unit. Used as such, the NFB would perform probably its most useful function, i.e., the cancelling out of power pack noises, whilst

the addition of a shunt resistor as shown in Fig. 4 would render the valves suitable for use in a 12 volt circuit, as well as in a six-volt one.

"Not so Dusty" Vision

By "TECHNICIAN."

With their noses glued to the "works," how often, alas, are our admirable scientists unable to "see the wood for the trees"! Take the average television receiver.

The amount of brain wracking that's been done to produce that superb picture transposed into pure energy, would pull a train from Lands End to John O'Groats.

Yet, but twelve months from buying his television, the viewer, too, can't see the "wood"—for the dust in between.

Dust, that inveterate enemy that provides the world's housewives with the bedrock of their occupation, settles everywhere, and the face of the cathode-ray tube is not an exception.

Every day, an insidious layer of the stuff attaches itself to the inside of the protecting glass and to the face of the tube. In three or four months, the three-megacycle bars on Test-card "C," become a thing of the past altogether, and are rapidly followed into dusty oblivion by the two-megacycle bars, the highlights, and all the details that make up enjoyable viewing.

The external face of the glass is easily cleaned, but without the help of a service engineer it's quite impossible, in the majority of receivers, to get at the inside and the tube-face.

The only thing to be done is to call in the engineer, and get him to remove the tube and "chassis."

A quick clean, and the receiver, then, is all right for another few months; but what a bother!

A Hinged Window

A tip for ardent viewers who like their TV "clean"—and permanently so—is to have the protecting glass removed altogether, and a filter-lens fitted to the outside of the cabinet.

Then, it is just a matter of removing the three or four screws fixing the lens to get at the inside dust, and this may be done without technical aid.

To those who have a flair for woodworking, the making of a small hinged door—"window," if you like—to be fitted to the cabinet exterior and just large enough to cover the tube-face, would present no difficulty.

The protecting glass, or lens, could be fitted into such a door, and access to the dust be gained at any time by simply opening the door.

This is a real need; manufacturers, what about it?

SAMSONS SURPLUS STORES

USEFUL TUNING UNIT

(see page 456)

A solidly built variably tapped inductor wound with silver plated heavy gauge wire. Fitted with vernier dial. 17s. 6d.

Hundreds of useful bargains in stock for radio constructors.

169/171 Edgware Road, London, W.2.
Open all day Saturday
Pad. 7851

ADCOLA

(Regd. Trade Mark)

SOLDERING INSTRUMENTS



Reg. Design No. 860302

(British, U.S. and Foreign Patents)

Designed for wireless assembly and maintenance. Supplied for all volt ranges from 6/7v to 230/250v.

3/16" Dia. Bit Standard Model 22/6

Sole Manufacturers ADCOLA PRODUCTS LTD.
Sales Offices and Works: Cranmer Court,
Clapham High St., London, S.W.4. (MAC 4272).

EASILY CALIBRATED SLOW MOTION DRIVE

By NORMAN F. WEBB.

Many radio constructors who have bought one of the TU9B series of tuning units for the cabinet, or the generous metal screening, or the velvet vernier knobs, may have wondered what they can do with the worm-driven slow motion drive, operated by thumbing the rim of a knob marked 0-100. It is such a solid precision-engineered job it seems a pity to leave it lying in the junk box.

I have converted this mechanism into a first rate drive assembly, free from back-lash and neatly adapted for use where a dial that can be easily calibrated by the constructor is required.

Here's how it is done:

First, get the drive out of the TU9B. This is easier said than done, but if you paint the grub screws of the flexible coupler (on the

condenser side, of course) with amyl acetate (which you can get from the chemists) and go to work with an allen key, it can be done.

The screws that hold the drive to the panel are easily loosened. Save the screws, you'll need them.

You can use the TU9B panel as a template to mark out the position of the holes needed to mount the assembly on a new panel. Note that the knob is mounted horizontally, not vertically, as on the TU9B. Drill the holes and, with a fretsaw, cut out the space for the knob.

Now we need a holder for a pointer. This is made from a bit of sheet brass (an old condenser plate) or other solderable metal cut to the shape shown in the sketch. The

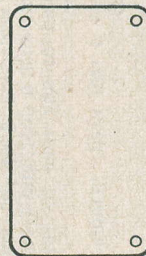

ONE PIECE OF PERSPEX



ANOTHER PIECE OF PERSPEX WITH A SEMI-CIRCLE CUT OUT SAME SIZE.

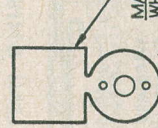

SHAPE THE PIECE OF BRASS SHOULD BE CUT TO FORM THE POINTER HOLDER



COLLAR

HOLDER IS BENT INTO THIS SHAPE & THE POINTER IS SOLDERED INTO THE COLLAR



THIS POINTER IS A PIECE OF STIFF BRASS WIRE OR A SEWING NEEDLE

POINTER FITS ON HERE

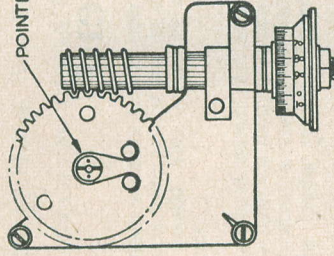

SKETCH OF THE WORM-DRIVEN ASSEMBLY TAKEN FROM THE TU9B

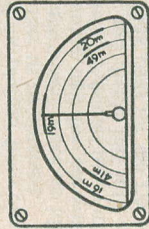

SHOWING THE ASSEMBLY WHEN BUILT UP

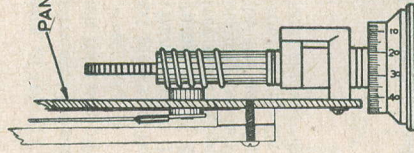

END ELEVATION OF THE DIAL SHOWING THE TWO PIECES OF PERSPEX THE POINTER & THE PANEL

0-25 graduated metal disc can be used as a template for the three holes needed, one to take the screw, the other two to fix over the little pegs that hold it rigid. Note that the holes have to be drilled in line with the collar of the pointer holder.

The pointer can be a piece of stiff brass wire (or even one of the XYL's sewing needles, if big enough!).

Now for the "window." This is made from Perspex. You can get a sheet from the local model shop. Decide how big a window you need, and cut two sheets of Perspex, this size. Clamp the sheets together and drill a fixing hole in each corner.

On the one sheet inscribe a semi-circle just a little bigger than the arc the tip of the pointer will describe.

With a fretsaw, cut out the semi-circle and file the edges smooth.

Put the Perspex over the panel so that the pointer holder and the pointer can travel their full track without fouling the Perspex,

mark where the four holes in the corner of the Perspex fall, and drill them out.

Prepare a white card the size of the Perspex and make a hole big enough to clear the pointer holder.

Now to assemble. Mount the drive on the back of the panel. Place the white card over the front of the panel. Screw on the pointer holder. Put on the Perspex sheet with the semi-circular hole. Put the other sheet on top of that. Slip the bolts through the fixing holes and tighten up the nuts. And there's the dial.

When you are calibrating, you can leave off the top sheet of Perspex. This gives you access to the white card, but does not allow the card to slip about, which is important.

For a signal generator, you can mark the frequencies straight on to the card. For a short wave receiver you can mark on the card where the bands fall by means of thick black lines, and take more exact dial readings from the graduated knob.

Kit and Component Reviews

1. Tuning Unit

Samsons Surplus Stores, of 169/171 Edgware Road, London, W.2., have sent for our inspection a tuning unit which they are offering for 17s. 6d.

This item is a tapped inductor, built on a very solid bakelite framework. The coil consists of some 37 turns of $2\frac{3}{4}$ " diameter, wound with 12 swg silver plated copper wire. The tapping is continuously variable, good contact being ensured by the use of a spring-loaded plunger. The control spindle is fitted with a vernier dial arrangement to enable

accurate re-setting, and the control knob is fitted with a hinged handle to enable quick travel of the plunger from one end of the coil to the other to be obtained.

The unit would make an ideal basis for an aerial tuning unit for use with a low power transmitter. Another use would be to remove the coil and divide this into smaller units as plug-in tank coils for the PA stage of a transmitter, when the bakelite framework would make a very attractive table lamp standard. Other uses will, no doubt, occur to readers of an inventive mind.

2. All-Dry Battery Operated Signal Tracer and Audio Oscillator Kit.

(Henry's Radio, 5 Harrow Road, London, W.2.).

This kit makes up into a most versatile instrument, enabling the progress of a signal to be traced through a faulty receiver from input to output, so that the source of the trouble may be quickly located. Amplifiers may be checked in like manner, and also for distortion. The tracer itself may also

be used as an AF amplifier. An audio oscillator is incorporated, and this can be used either separately or in conjunction with the tracer section.

The tracer section consists of a high gain, two stage amplifier using an IT4 followed by an IS4, plus a crystal diode. Resistance/capacitance coupling is employed, and a speaker is built in. Automatic bias is applied to the output stage.

The audio oscillator section employs a IT4 valve, triode connected, the necessary feedback from anode to grid being transferred by an AF transformer. The output from this section is taken via a 250 k Ω potentiometer, capacitance coupled to the anode.

The kit supplied is absolutely complete, even to the battery (type B114), cabinet and such small items as wire, screws, solder, etc. The polished wood cabinet is a particularly fine job, with hinged lid giving access to the speaker and controls, and a sliding panel for insertion of the battery.

The cost of the kit is £4. 19. 6, or it may be obtained fully assembled for an additional charge of 15s. A constructional booklet is available at 1s. 6d., and parts may also be obtained separately at retail prices.

JACKSON RADIO

163 Edgware Road, London, W.2

Components for the 16" TV and View-master. Huge selection of valves both pre-war and post-war

Everything for your radio. Radio Sets from £5

Cheapest in Town—callers only

3. Premier 2-Valve AC Medium Wave Receiver

(Premier Radio Co., 207 Edgware Road, London, W.2.)

This receiver, which we have seen in operation, is ideal as a standby or for use in the kitchen, etc. It would also serve as an efficient signal tracer.

Reference to the circuit shown here and to that of the Baby Alarm kit recently reviewed shows that this receiver is exactly the same job except for the tuning section. Premier

Radio will, in fact, supply the Baby Alarm kit less microphone and input transformer for this purpose, at 64s. 6d. The only additional components then needed are a two-winding medium wave coil (the Premier Red Spot coil is ideal), a 100 pF fixed condenser, a 30 pF trimmer and a 500 pF tuning condenser. The latter may conveniently be of the reaction type for compactness.

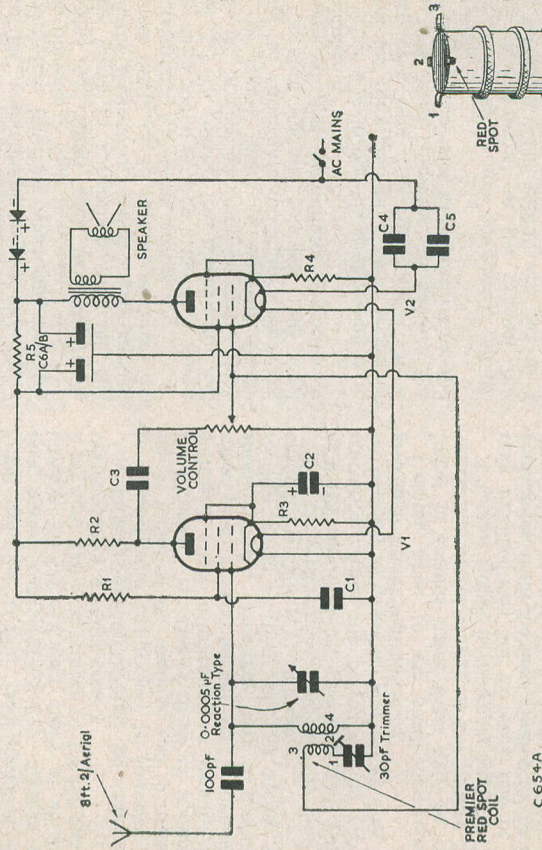

Premier 2-Valve AC Medium Wave Receiver

Component Values

R1	2.2 Meg Ω	C1	0.005 μ F
R2	470 k Ω	C2	0.5 or 1 μ F
R3	3.9 k Ω	C3	0.005 μ F
R4	100 Ω	C4	1 μ F
R5	27 k Ω	C5	1 μ F
Volume control with switch.		C6A/B	16-16 μ F 350V electrolytic

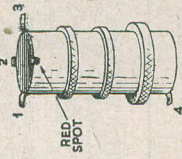

USES FOR SURPLUS MOTOR GENERATORS

By T. H. O'DELL

There have been, for many years now, a large number of dynamotors and small motor generators for sale on the surplus market. These machines are usually converted into AC or DC commutator motors, but there are other uses for them which are, perhaps, not so obvious.

Motors of ratings such as 28V 100A, usually found in connection with the 400 c/s motor alternators, are strangely enough the most useful of all surplus machines for conversion into AC mains motors.

The basic circuit of such a motor is shown in Fig. 1. To convert this machine for AC mains, the brushes are removed and a thick piece of copper braid is wrapped tightly around the armature commutator's segments, and the ends soldered together, thus short circuiting all the commutator segments to one another.

A better way to do this modification is to remove the rotor and fit a short length of copper tube over the commutator. It is often very hard, however, to remove the rotor due to the tight fit of the frame and ball races.

The conversion is now completed, and the mains are connected to the original 28V input terminals. The motor will run as a

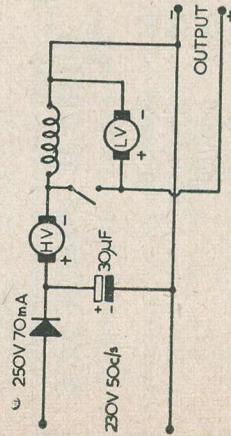

FIG. 2
CIRCUIT OF LOW VOLTAGE SUPPLY UNIT

C661

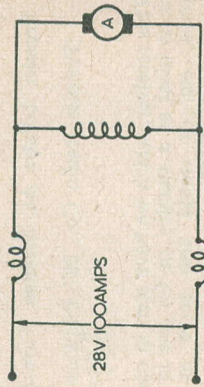

FIG. 1
TYPICAL MOTOR SUITABLE FOR AC CONVERSION

C660

50 c/s induction motor, despite its strange appearance. The spindle speed will be about 2,800 rpm for a two pole machine, and about 1,400 rpm for a four pole one. A 28V 60A motor converted in this manner can develop 1/8-1/4 HP very easily at about a 5 per cent. fall in speed; up to 3/8 HP can be developed for a short period.

A large condenser should be connected in parallel with the motor, to improve the power factor of the machine and to increase its efficiency. A value of 10-20 µF is usually sufficient. Any overheating is usually due to a poor connection on the commutator shorting braid. This may have to carry up to 30A when starting, etc., so arcing will ensue if the band is at all loose.

This conversion applies only to 28V motors, as a 12V motor would have too small a field reactance. Also, the current rating should be as high as possible, and above 50A, to give high power and efficiency.

Passing, now, to the small dynamotors found in surplus units, these may be converted into useful sources of low voltage DC. A typical circuit is shown in Fig. 2. The only modifications are to break one of the leads going from the field winding to the low voltage commutator and insert a switch, S1. The commutators are then wired in series, as shown, observing correct polarity. The polarity is usually marked on the frame, above the brush holders.

DC is then applied, with S1 open, of the same voltage as the original HT output. When the armature is revolving, S1 is closed and the original motor section will run as a dynamo.

One of the small Command Receiver dynamos, 28V 1.7A input and 270V 70 mA output, when modified in this manner gave a steady 16V at 0.5A, 15V at 1A, and 18V on open circuit. It was run off a small 75 mA metal rectifier as shown in the diagram, Fig. 2.

from our



Mailbag

MORE MNEMONICS

Two readers have responded to the writer's recent paragraph on the subject of radio mnemonics.

W. Jackson of Chester-le-Street, Co. Durham sends in the following useful reminders for circuit relationships:-

Watts = You can't do
Amps × Volts or IV = WIVout it!
also Volts V = Vulcanised

or
Amps × Resistance IR India Rubber"
Both fractions are, of course, equal to unity.

The other mnemonic comes from S. Holme of Brockley, S.E.4. This one concerns the resistor colour code.

"Better Be Right Over Your Grid Bias Values (for) Working Good"
0 Black
1 Brown
2 Red
3 Orange
4 Yellow
5 Green
6 Blue
7 Violet
8 Grey
9 White

Excellent advice and a very useful reminder! Do other readers know any more of these mnemonics? All are welcome, and all will be acknowledged.

J.R.D.
(In Your Workshop).

REGULATORS IN PARALLEL

I was interested to read J.R.D.'s comment on oscillator stability in his June contribution 'In Your Workshop', and there seems every possibility that his scheme could work. There is one point which, rightly or wrongly I feel might have escaped him, so I hope he will not mind my submitting a few words regarding it. When two neon regulator tubes are connected in parallel there is a danger of only one of them striking when voltage is applied; there is in fact a race between them and the first one home gets the prize. If therefore strikes with great joy, and immediately pulls down the applied voltage to its running value. From there on it's a case of I'm all right Jack—the other tube sits there looking dark and glum about it all, simply because the voltage is now

at running value and below its striking value. In actual fact, Tube No. 1 bites off more than it can digest; by being greedy and snatching the lead it also takes unto itself a gross current overload, and consequently can't stand the strain, so just dies. In probability it will, in its death-throes, pass the buck to Tube No. 2—this poor inoffensive being will then have the agonies of its demised partner thrust upon it, so it, too, will take up a hopeless struggle with a death-dealing adversary. Result, two VR.150/30's ready for the dustbin.

Neon regulators are rather temperamental things, and their striking voltage alters somewhat with ageing, so although two tubes may have the same characteristics when new there might be considerable differences after some operation, depending on the actual conditions of use. Both temperature and light (or absence of light) causes changes in striking voltage. There was an article in the December 1950 issue of "Electronic Engineering," by R. E. Harvison, in which he discussed some investigations into this matter of parallel operation with particular regard to the STV.280/80 Stabilivolt multi-gap regulator tube, and devised a means of ensuring long-term simultaneous striking. The circuit developed appears to be capable of adaptation to single-gap tubes of the VR.150/30 type.

I hope our friend J.R.D. will not mind me mentioning this article, and will not think of me as quoting scriptures to add weight to my words here. I appreciate that he puts forward this idea for stable voltages as something that readers might like to experiment with—my comments here are intended only to point to a possible pitfall in such work, and not to decry his suggestion or even to deter independent research by readers who may not know about this peculiarity of neon regulators.

Yours sincerely,

W. E. THOMPSON.
(St. Leonards-on-Sea).

Abbreviations, Symbols and Simple Formulae

USED IN RADIO AND ELECTRICAL CIRCUITS PART 1

Compiled by H. E. Smith, G6UH

(The following data has been compiled at the request of a number of readers, and will, it is hoped, be of assistance to the beginner and to the more advanced reader who has no ready access to all of the information given. The symbols have been grouped in order to provide a quicker reference.)

Commonly used Abbreviations

- AC, Alternating Current.
- A, Amperes.
- AM, Amplitude Modulation.
- Ant. or Ae., Aerial.
- AF, Audio Frequency.
- cm., Centimetre.
- CW, Continuous Wave (Telegraphy).
- cps or c/s, Cycles per second.
- dB, Decibel.
- DC, Direct Current.
- EMF, Electro motive force.
- f, Frequency.
- FM, Frequency Modulation.
- gnd or E, Earth.
- H, High Frequency.
- HF, High Frequency.
- if or IF, Intermediate Frequency.
- ICW, Interrupted Continuous Waves.
- kc/s, Kilocycles per second.
- kV, Kilovolt.
- kW, Kilowatt.

- mmf or F, Magnetomotive Force.
- mmF, Microfarad, (picofarad).
- μF, Microfarad.
- pF, Picofarad.
- MF, Megacycles per second.
- Mc/s, Microfarad.
- m, Microfarad.
- μH, μfd, or mfd, Microhenry.
- μV, Microvolt.
- μV/m, Microvolt per Metre.
- μW, Microwatt.
- mA, Milliampere.
- mV, Millivolt.
- mW, Milliwatt.
- MCW, Modulated Continuous Waves.
- P, Power.
- PF, Power Factor.
- RF, Radio Frequency.
- UHF, Ultra High Frequency.
- VHF, Very High Frequency.
- V, Volts.
- W, Watt.
- As applied to Valve Circuits
- L, Inductance (Henries).
- E, Resistance (Ohms).
- C, Capacitance.
- R, Resistance (Ohms).
- L, Inductance (Henries).

(To be continued)

"RECENTLY PEOPLE SEEM TO BE LOSING CONFIDENCE IN OUR BROADCASTS."

Reprinted from SUMMER PIE

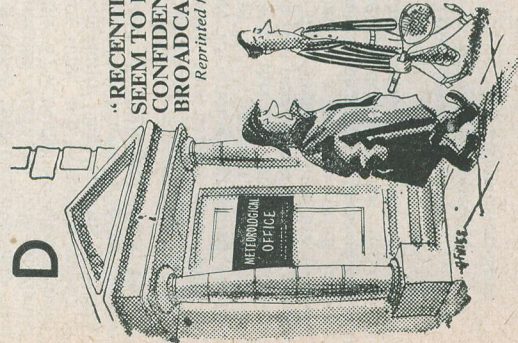

Britain's favourite pre-war summer annual, SUMMER PIE, will be on sale from all newsagents and booksellers on Thursday, June 12th, price 1s. 6d.

Contents include a hilarious slice of autobiography by Ted Ray; some highly original revelations of the way a Russian girl spy gets to work, by Norman Phillips; a description by Elkan Allan of a fascinating film festival in Uruguay, and complete fiction stories by half a dozen first-class writers. SUMMER PIE is illustrated throughout by leading British and American cartoonists, giving an added gaiety to this lively publication.

The entire profits from the magazine are to be devoted to the National Advertising Benevolent Society.

Useful Accessories

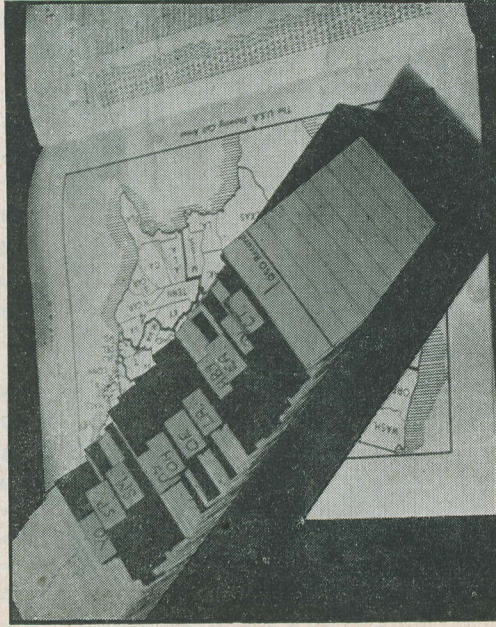

'Minicard' Record Cards

from—
A.S.W.P.
57 Maida Vale
Paddington
LONDON, W9

GSO RECORD CARDS 2½ ins. x 2½ ins. printed both sides, available for Amateur Station records, at 3/3 per 100 post paid. Metal filing trays as shown, heavy gauge steel, green enamel to hold 500 cards, 3/3 post paid. Indices not available.

THE RADIO AMATEUR

is a monthly journal which deals with all aspects of short wave radio. The constructional side describes short wave receivers, transmitting equipment, aerials, test apparatus, etc.

The amateur, VHF and broadcast bands are covered in separate articles, each contributed by an expert.

The Radio Amateur is obtainable from your local supplier price 1/9 or by subscription 10/6 for 6 months or 21 shillings for 12 months — post free.

AMALGAMATED SHORT WAVE PRESS LTD.
57, Maida Vale, London W.9.

G4GZ's BARGAINS

VALVES: 6C4, 9002, 9003, 6/6, 12A6M, 6CSGT, 6J7G, 6K7GT, 7/6, 6AG5, 6L7M, AC6Pen, 8/6, 954, 955, 956, 1N22, VU111, 5/1, 1R5, 1S4, 1T4, 10/6.

USEFUL TOOLS: comp. set 5 Allen keys 1/16"–1/8", 1/8"–1/4", 1/4"–3/8", 3/8"–1/2", 1/2"–5/8", 5/8"–3/4", 3/4"–1", DE 9" Box spanner 4 x 6BA, 1 set Terry's 2, 4, 6BA, 5/9. Set Socket spanners (7) 0-6BA, with wrench 5/1- or the two kits for 10/1-.

MAINS TRANS: 230v input, 220, 260, 300v, 80m/A (HW) 5v, 5 amp output, ONLY 9/6 each, EF50 car. v/hdrs. 1/2 each, 10/1- to W/V Pots. 1K Lin 10W, 10K Lin. 10W, 7/6 each. Panels containing 4, .01 mfd, 500v. w/kg. mica and 2, HF chokes 1/- each.

GOOD STOCKS OF NEW COMPONENTS AND EQUIPMENT ARE ALSO IN STOCK such as Lane Tape Tables £16/10.0 (car. 7/6). Scotch Boy and EMI Tape. All Viewmaster kits and components, Haynes TV gear. Full range of BVA valves at BOT prices. Osborn, Wemouth and Wearite coils. Denca components. Wooden transformers, Bernards Books, TCC and Dubilier condensers. ETC., ETC., ETC., Let us have your enquiries.

Post/packing 1/- under £1, 2/- under £3.

J. T. ANGLIN
160, CLEETHORPE ROAD, GRIMSBY, LINGS.
Tel.: 56315.

The most reliable rectifiers for TELEVISION RECEIVERS

Westinghouse metal rectifiers have proved themselves the most reliable and efficient since they were established over 26 years ago. Continuous research and development has kept them at the top and the current units for television H.T. and E.H.T. supplies incorporate double-voltage and quadruple elements respectively, increasing both their efficiency and output. The small copper oxide "Westectors" are also used extensively in sound and interference suppression circuits. For further particulars of . . .

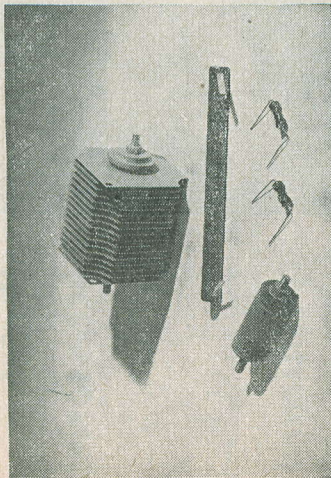

METAL RECTIFIERS

write stating your requirements to . . .

Dept. R.C.1
WESTINGHOUSE BRAKE & SIGNAL CO. LTD., 82 York Way, King's Cross, London, N.1

PREMIER

(REGD.)

RADIO B. H. MORRIS & CO. (RADIO) LTD.

ESTAB. 40 YRS.

TELEVISION



'BABY'S CRIES CAN BE HEARD' IN ANY SELECTED ROOM'

A tremendously improved and re-designed version of the famous Premier Baby Alarm Kit, consisting of a Kit of Parts in Plastic Cabinet, to construct a device to enable Baby's cries, or even Creaking, to be heard in any selected room in the house. Consists of a 2-valve Amplifier (A.C. mains operated 200/250 volts) with a Midget Telephone incorporated in the Kit which, together with other improvements in the design, have resulted in tremendously improved sensitivity and quality of reproductions. May be left permanently connected to Extra Microphones in different rooms. May be used without impairing the efficiency of the unit. The lead from Microphone to the unit may be up to 60 ft. in length. Complete with valves, Circuit and Instructons. PRICE £3.9.6

* To those unable to build this Baby Alarm we can offer it completely wired and tested at 7/6 plus 2/6 packing and carriage.

PREMIER De Luxe BABY ALARM
This is a completely wired and tested amplifier, housed in a grey rexine-covered cabinet. Entirely self-contained for use on A.C. or D.C. mains supply of 200/250 volts, already assembled and ready to plug in.
The unit is so constructed that in addition to functioning as a Baby Alarm, provision is made on the control panel so that the unit can be used as a gramophone amplifier and as a means of amplifying speech. Ideal for use at parties and all similar functions.
Owing to increased production facilities, we are now able to offer this unit at almost half the original cost.
Plus 7/6 packing and postage. £6.19.6

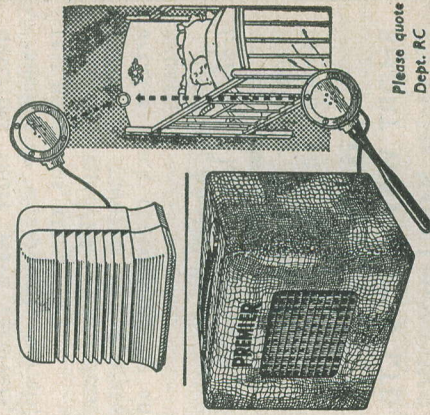

Please quote Dept. RC

Phones: AMBASSADOR 4033 & PADDDINGTON 3271/2
207 . EDGWARE ROAD . LONDON . W.2

HENRY'S

5, HARROW ROAD, LONDON, W.2.
Tel.: PAD 1008/9 and 0401.

A COMBINED SIGNAL TRACER AND AUDIO OSCILLATOR

An easy-to-build unit that can be used for I.F. and Audio Signal Tracing, without any switching or tuning, including variable output oscillator for amplifier checking. Highly sensitive, responds to signals picked up from an ordinary receiving aerial.

The circuit is that of a high-gain 2-stage, resistance-coupled audio frequency amplifier, employing 3 miniature 1.4 valves, with a 3-inch speaker in the Output of the Power Amplifier Stage. An added advantage being that as this unit is "All-Dry" it can be used with safety on AC or AC/DC mains and battery sets. The complete kit with portable cabinet (size 6" x 7" x 6" and battery weighs only 4 lbs.

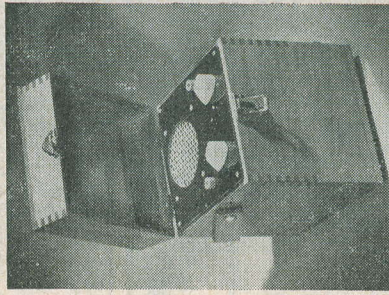

We shall be pleased to supply a complete kit for the construction of the above, right down to the last nut and bolt, including 2-1T4 and 1-1S4 valves, 3" speaker and portable case and All-Dry Battery for

£4-19-6

Concise instructions and circuits supplied. If preferred, circuit and instructions only can be supplied for 1/6. If required, this Unit will be assembled and tested for extra charge of 15/-. This is a highly efficient instrument, and a MUST for every radio man. Send stamped addressed envelope for 28 page Comprehensive Catalogue.

Presenting the "BURGOYNE" Tape Table

A Sound Precision Product

First-class value for money

*Precision built. *3 motors with ample reserve of power. *Fast re-wind facilities. *Tape speed: 7 1/2 in. per second. *Heavy precision balanced Half track width high impedance. *Half track width high impedance heads. *Veellegible "wow" and "flutter." *Take up spool supplied. *Circuit diagram included. *For use on A.C. mains.

THE BURGOYNE CABINET Polished walnut of attractive appearance. Strut hinges and locking clips. (cart., pkg., 5/-).

£4.10

£16.10s.

CASH or £6.10 Deposit and 12 monthly payments of 20/- Plus 10/- cart. and packing.

THE BURGOYNE OSCILLATOR UNIT Assembled and (post and packing 2/-) 42/-

5-in. P.M. LOUDSPEAKER Well known makes only. (post and packing 1/6) 15/-

E & G MAIL ORDER & SUPPLY CO.
33, Tottenham Court Road, London, W.1. MUSEUM 6667



CLYDESDALE

Bargains in Ex-Services Equipment.

FOR INEXPENSIVE TELEVISION.
I.F./A.F. AMPLIFIER UNIT R.135 CARRIAGE PAID. 67/6
R.F. UNIT TYPE 27 In original carton. CARRIAGE PAID. 63/-
THE 5 CPI CATHODE RAY TUBE. In original carton A 6 inch electrostatic tube. Heater vgt. 6.3V. 0.6 A. Ht. 4,000 Volts max., intensifier gives high definition. Trace colour green, short persistence.

CLYDESDALE'S PRICE ONLY £11-15-0

POST PAID.

THE R.3601 RECEIVER UNIT.

A 15 Valve (6V6, VU39A, 4J5P61, 4J5A50, 2J5F54, EF50 EC52, VU111) 12 val chassis. I.F. receiver for 223 mc/s with 13 mcs. I.F. Strip R.F. Section, high cycle power section, antenna switch, relay, etc., etc. In metal case

CLYDESDALE'S PRICE ONLY £4-12-6

CARRIAGE PAID.

DOUBLE COIL RELAY. Single make contact with adjustable screws. Coil of 300 ohm resistance operates at 9 volts. Dimt. 1 1/2 x 1 1/2 in. dia. C. coils of 101 ohm resistance operates at 1.5 volts. Dimt. 1 1/2 x 1 1/2 in. dia. Overall dimensions (including coil diameter) 3 1/2 x 3 x 1 1/2 in.

CLYDESDALE'S PRICE ONLY 1/6 EACH POST 9d.

NEW LIST No. 88 Now Ready - Price 1/6d. Price credited on first purchase of 10/- or over.

Order direct from:

CLYDESDALE SUPPLY CO. LTD.

2 BRIDGE STREET, GLASGOW G.5.

Branches in Scotland, England and North Ireland.

SCOTTISH INSURANCE CORPORATION LTD.



62-63 CHEAPSIDE LONDON, E. C. 2.

TELEVISION SETS AND SHORT WAVE TRANSMITTERS

Television Sets and Short Wave Transmitters/Receivers are expensive to acquire and you no doubt highly prize your installation. Apart from the value of your Set, you might be held responsible should injury be caused by a fault in the Set, or injury or damage by your Aerial collapsing.

A "Scottish" special policy for Television Sets and Short Wave Transmitters/Receivers provides the following cover:—

- (a) Loss or damage to installation (including in the case of Television Sets the Cathode Ray Tube) by Fire, Explosion, Lightning, Theft or Accidental External Means at any private dwelling house.
 - (b) (i) Legal Liability for bodily injury to Third Parties or damage to their property arising out of the breakage or collapse of the Aerial Fittings or Mast, or through any defect in the Set. Indemnity £10,000 any one accident.
 - (ii) Damage to your property or that of your landlord arising out of the breakage or collapse of the Aerial Fittings or Mast, but not exceeding £500.
- The cost of Cover (a) is 5/- a year for Sets worth £50 or less, and for Sets valued at more than £50 the cost is in proportion. Cover (b) (i) and (ii) costs only 2/6d. a year if taken with Cover (a), or 5/- if taken alone.

WHY NOT BE PRUDENT AND INSURE your installation—it is well worth while AT THE VERY LOW COST INVOLVED. If you will complete and return this form to the Corporation's Office at the above address, a proposal will be submitted for completion.

NAME (Block Letters)
(If Lady, state Mrs. or Miss)
ADDRESS (Block Letters) /JB

"YOU CAN RELY ON US"

BRIMAR OSRAM MULLARD Valve Manuals 5/- each

SELENIUM RECTIFIERS
36EHT50 — 24/6 New Westinghouse—
36EHT 100-30/6, 14A86-20/-, 14D36-12/-,
WX3-3/9, WX6-3/9, 36EHT45, 20/6.

LINE CORD 3-WAY
0.2amp 100Ω per foot—8d. Ft.
0.3amp 60Ω per foot—8d. Ft.

DROPPERS
Standard 0.3A 800Ω, 5/-, 0.2A 950Ω 5/-,
Midget 6/3 each 2 1/2 high.

SURPLUS VALVES
Here are a few—write for out "Valve Bargain List", with over 120 types
6AG5-9/6, 6H6m-4/6, 12A6m-8/-, 3A4-7/6,
6K6gt-8/6, 30S-8/6, 6J5g-6/6, 6SHY metal-7/6,
6W6-12/6, 6BE-15/-, 6A16-10/6, 6BA6-12/6,
50C5-13/6, 6U5G 6.3v octal Magic Eye-7/6.

TUBULAR CONDENSERS
0.001, 0.002, 0.004, 0.005, 0.01, 0.1 6d. each
0.25μF, 1/- each, 0.5μF, 1/6 each.

MICA CONDENSERS
0.0001, 0.0002, 0.0003, 0.0005, 0.001, 0.002,
0.005, 6d. each.

VALVE CANS
3 piece aluminium (Octal valves) 1/6 each.
TRIMMERS
30pF 50pF-9d., 100pF 150pF-1/-, 250pF-1/7,
500pF-2/-, 750pF-2/3.

And we sell 'TV Fault Finding' 5/3 post paid.
Write for our 32 page catalogue No. 11
Price 6d.

RADIO SERVICING COMPANY (Dept. K)
444, WANDSWORTH ROAD, LONDON,
S.W.8. Macaulay 4/55.

SMALL ADVERTISEMENTS

Readers' small advertisements will be accepted at 2d. per word, minimum charge 2/-. Trade advertisements will be accepted at 6d. per word, minimum charge 6/-. If a Box number is required, an additional charge of 1/- will be made. Terms: Cash with order. All copy must be in hand by the 12th of the month for insertion in the following month's issue.

PRIVATE

WANTED. Instruction sheet or copy for SWN Short-wave 1 valve (DF91) receiver, battery operated. Sharp, 29, Gravel Hill, Henley-on-Thames, Oxon.

RX LOG BOOKS. Superb quality, containing 50 pages printed both sides on first class paper and bound with heavy cover. Price 4/6, post free. Please send SAE for sample sheet. B. Sutton, 117, Utting Avenue East, Liverpool, 11.

R1224A. Modified output, spare valves, accumulator, £5. 10. 0. Stanton, Douglas House, Blackfriars Road, King's Lynn.

FOR SALE. Amateur's surplus equipment. Rx's, components, cheap. SAE for list. Trevor Woods, 12, Lansdowne Road, Southampton, Lanes.

FOR SALE. R1155 Power Pack and Speaker. What offers? Box No. B 194.

FOR SALE. Eddystone S640 receiver, sound condition with new 8 inch speaker, £20. Also complete kit of parts for a 4 valve personal receiver, £5. 3s. Chandos Road, East Finchley, LONDON, N.2.

R1116. Good condition, £7. 10. 0. 58 Walkie-Talkie complete with accessories £10. 0. 0., or offers for either. Box No. B 180.

FOR SALE. Columbia gramophone motor, AC, single speed. Decca lightweight pickup. In a bakelite cabinet, £9. 0. 0. C. Scarlet, 12, Gerald Road, London, S.W.1.

FOR SALE. Eddystone S640 receiver. Excellent condition no reasonable offer refused. Benion, 33, Douglas Road, Sutton Coldfield, Warks.

FOR SALE. VCR 517, 15/-, VCR 97, 25/-, Also 12" electrostatic VCR 131, £4, or offer, all new and unused. Kierman, 10, Shalston Villas, Surbiton, Surrey.

FOR SALE. £1, Radio Constructor Vol. 4, bound imitation leather Morocco. 10/- for copies Vol. 5 Nos. 1 to 8. 30/- three volumes Wireless World 1949-1950, bound imitation leather blue. 1951 loose. Collins, 11/7a, Dane Road, Southall, Middx.

VALVES and other useful parts including CRT and EHT components, SAE for list. Box No. B 193.

OFFERS. 2 volt Type 58 Vibrapak, 18 Receiver, 21 Receiver and Transmitter, Packard Bell Amplifier, 6 volt Vibrapak, Box No. B 192.

EXCHANGE. 3800' bobbin "Crown" recording wire and two spools (unused) for 1200' spool of unused Emitape, or 35/-, W. Knill, 28, Fort Street, Barnstaple, Devon.

Building a Televisor?

THEN CONSIDER THE FOLLOWING

RECEIVER R.1355, as specified for "Inexpensive Television." Complete with 8 valves VR65 and 1 each 5U4G, VU120, VR92, also a copy of "Inexpensive TV." ONLY 55/- (carriage, etc., 7/6). Copy of book only 2/6.

I.F. STRIP 194. Another of the units specified as an alternative for the "Inexpensive TV." A first-class strip giving tremendous amplification, and well recommended for constructors who have vision or visors but have come "unstruck" in the built or sound-receiver. Complete with 6 valves VR65, and 1 each VR53 and VR92, and a copy of the book, which gives full details of CONVERSION to both stations. Size 18in. x 5in. x 5in. ONLY 45/- (postage, 2/6).

"PYE" 45 mc/s. I.F. STRIP. Ready made for London vision channel. Complete with 6 valves EF50 and 1 EA50. ONLY 60/- (postage etc., 2/6).

RECEIVER R.3547. This contains the "PYE" Strip, which can be easily removed if desired, and also 15 valves EF50, 3 of EB34, 2 of SP61, and 1 each EA50, EB33, EF36, also hundreds of resistors condensers, etc. BRAND NEW IN MAKERS' CASES. ONLY 120/- (carriage, 7/6).

Cash with order, please, and print name and address clearly.

U.E.I. CORPORATION,

The Radio Corner, 138, Gray's Inn Road, London, W.C.1.

Open until 1 p.m. Saturdays. We are 2 mins. from High Holborn. 5 mins. by bus from King's Cross

NORMAN H. FIELD 68, HURST STREET, BIRMINGHAM, 5

Mail Order Department.

64-65, CHURCH LANE WOLVERHAMPTON.

CHEAPER VALVES
At 12/6: 6SN7, 6K8, X61, 607g, KT61, KT63, KT66, ECC32, 5Y35Z4, All Brand New and Boxed.
At 10/-: 12SC7, 1616, PEN46, 12SL7, 50G/GT, 6F7, 807, ARP6, IT4, IS4, IRS, IS5. At 7/6: VT52, LA52, EB33, VR55, 7R7, 77, 6K7, 6V7, VR150, 6G6/GT, IA5/GT, 7C7, VR119, 6V7/G, 7C5, ART2, TP25, OZ4, IA2A6, 12AC7, At 7/-: 6B8, 6B8G, 1G6/GT/C, 6K7G, MH4, VR33, EF39, EF36. At 6/6: 6AB7, 6D6, VT724, RK34, 2C34, AR8, HL23DD, ARP12, VP23. At 5/6: 6S57, 6R7, 6R7/GT, 12C8, 12SG7, 6C5/GT, 6T11, VT501. At 5/-: 6J5, 12SK7, 2A3, VU133, 2V3G, 1625, VT51, PENZOCA, VR118, KT2. At 4/6: 6J5/G, 6J5/GT, 12SH7, 12H6, VU120. At 3/6: RK272, ARP3, 9D2, 6H6. At 3/3: VR18, 2155G, 2X2, VU111, HL2, VR21, VR54, EB34, VR92, EA50, VR65A, SP41. At 2/6: VR34, EB34, VR92, EA50, VR78, DI, 7193. All boxed, Tested and Guaranteed.

Viewmaster.
Boost Chokes 3. MC 5/-
Coil Kits. 14 Collis & R.F. Choke 21/6
Plessey Focus Ring 22/6
Scanning Coils 29/3
Width Controls 7/6
Line Transformers E.H.T. 32/6
E.H.T. Transformers 2,500v 5 ma. 4v 2 amp. 0.2-4v amp. 210/250v 50 cycles. Completely water impregnated 45/-
Heater Transformers 25/3
ROTARY CONVERTORS: 6v input approx. 12/6
and 220v at 80 ma output. Pair 2/3
Belling Lee Plugs and Sockets. 5 pin New. 7/6
1155 Loop Aerials D.F. 8/6 CRYSTALS. 500Kca. 7/-
Please add something for postage.
Money Back Guarantee.

RADIO MAIL

4, RALEIGH ST., NOTTINGHAM

INTRODUCING

A RESISTANCE-CAPACITY BRIDGE

at 30/- only

Note the following points
LESS THAN ONE FIFTH THE COST OF
A COMMERCIAL INSTRUMENT OF
SIMILAR RANGE.

THREE CAPACITY RANGES. TESTING
UP TO 50 MFD. THREE RESISTANCE
RANGES. TESTING UP TO 5 MEGOHMS.
EASILY AND QUICKLY ASSEMBLED
WITH THE SIMPLE INSTRUCTIONS AND
CIRCUIT DETAILS SUPPLIED.

NO CALIBRATING NECESSARY AFTER
ASSEMBLY.

ALL CALIBRATIONS, SWITCH RANGE
MARKINGS, TERMINAL FUNCTIONS,
ETC., READY LAID OUT ON A HANDSOME
ESCUTCHEON COVERING THE ENTIRE
OPERATING PANEL.

THIS IS THE FIRST TIME THAT AN
INSTRUMENT OF THIS CALIBRE HAS
BEEN AVAILABLE AT SUCH A LOW
PRICE. ORDER NOW WHILE SUPPLIES
LAST.

STAMP FOR LIST AND WITH ALL ENQUIRIES
PLEASE.

Small Advertisements—cont.

Readers' small advertisements will be accepted at 2d. per word, minimum charge 2/-. Trade advertisements will be accepted at 6d. per word, minimum charge 6/-. If a box number is required, an additional charge of 1/- will be made. Terms: Cash with order. All copy must be in hand by the 12th of the month for insertion in the following month's issue.

PRIVATE

RADIO BOOKS for sale. 4 of any.—Radio Constructor, Wireless World, Practical Television, Practical Wireless, Radio-Craft for 2/6 plus 6d. postage. Also Radio Troubleshooters Handbook, USA E1 and Radio Physics, A. Chirardi. Wanted.—Television parts, Viewmaster or otherwise. R. Dansil, 111, Palmerston Road, South Stifford, Essex.

CAR RADIOS. Transreceivers, spares. Different types for disposal. Stamp for details. Brown, 40, Stamsaw Road, Portsmouth, Hants.

FOR SALE. Class D Wavemeter converted for AC mains, £6, VCR 97 with mask, holder and mu-metal screen, 30/-, Buyer collects. Box No. B 195.

TRADE

SPEAKERS. Plessey midget P.M. speakers, with transformers, 12/9 (2) and 3 (inch), postage 1/6. Duke's, 621, Romford Road, London, E.12. Tel: GRANGWOOD 6677.

Small Advertisements—cont.

TRADE

HIGH QUALITY TAPE RECORDER—easily constructed. Set of 3 Blueprints showing details of Desk and 10 watt Amplifier; full size; 10/-. Precision made parts supplied for desk—simple panel drilling complete. GM6LS, 15, Corstorphine Hill Road, Edinburgh.

TYPE 25/1196 short wave superhet receiver. Valves and some parts missing. Following remain:—4 tuning condensers, 32 fixed condensers, 28 resistances, transformers, switches, v/controllers, v/holders. Converts easily (free drawing), 7/9. Spare chassis (minus one bank of resistors and 4 v/holders) 3/9. Postage 2/-. Duke's, 621, Romford Road, London, E.12. Tel: GRANGWOOD 6677.

REQUIRED. Persons to undertake light work in spare time. Write: (77) Empire Co., 117, Nottingham Road, Loughborough.

REPRINT. Converting the TR1196 Receiver. Full details on converting this unit, which may be purchased quite cheaply, into a very sensitive all-wave receiver. 6d. post free. All the above from A.S.W.P., 57, Maida Vale, London, W.9.

"GLOBE-KING" (Regd) Miniature Single Valve Receiver gets real DX.—Amateur Radio enthusiasts should send for free copy of interesting literature and catalogue (enclose stamp for postage). Write to makers: Johnsons (Radio), 46, Friar Street, Worcester.

BOOKBINDING. Volumes of Radio Constructor and Short Wave News fully bound, imitation leather, gold lettering. 7s. 6d. post free. Prices for other publications on application. Jerome Alcock, CHEADLE, Stoke-on-Trent.

HOME CONSTRUCTORS. Radio, television, send for free list components, valves, kits, speakers, etc. The Radio Equipment Company (RC Dept.), Castor Road, Brixham, Devon.

TV COILS, ALL TYPES.—Bell Sound Products Co., Marlborough Yard, London, N.19. ARC 5078.

E. M. I.

JOB or HOBBY.—Whichever it is in Radio or Television, we can help you. Backed by the great E.M.I. organisation, we can offer the most authoritative and up-to-the-minute Home Study courses in Radio Television and Electronics. FREE BROCHURE from E.M.I. INSTITUTES, Postal Tution Division Dept. RC.11, 43, Grove Park Road, Chiswick London, W.4. Chiswick 4417.

ANOTHER MILLER EXCLUSIVE. "Moli," the hammer finish, as used on commercial tape recorders, amplifier cases, etc. Grey, Green or Blue. For brush application, air drying. 4/6 inc. or SAE for details. Miller, 8, Kenton Park Crescent, Kenton, Middx.

VIEWMASTER. exact specified parts at list price by return of post, also Valves and CRT's, stationery list. James H. Martin and Co., Dept. RC, BCM/EDHWA, London, W.C.1.

THE MODERN BOOK CO.

The Radio Amateur's Handbook 1952. Price 30s. 0d. Postage 1s. 0d.
Inexpensive Television for the Home Constructor. Price 2s. 6d. Postage 2d.

Sound Reproduction. By G. A. Briggs. Price 10s. 6d. Postage 6d.
Television Principles and Practice. By F. J. Camm. Price 25s. 0d. Postage 6d.

P. H. Brans' Vade-Mecum 1952. Price 25s. 0d. Postage 9d.

Radio Valve Data. Compiled by "Wireless World." Price 3s. 6d. Postage 3d.

Magnetic Recording. By S. J. Begun. Price 25s. 0d. Postage 9d.

We have the finest selection of books in the Country.

19-23 PRAED STREET (DEPT.), LONDON, W.2
PADDDINGTON 4185.

Complete list on application.

Television Receiver Practice. By R. Holland. Price 5s. 0d. Postage 3d.

The Oscilloscope Book. By E. Bradley. Price 5s. 0d. Postage 3d.

Feedback. By N. H. Crowhurst. Price 3s. 6d. Postage 3d.

Cathode-Ray Oscillographs. By J. H. Reynier. Price 15s. 0d. Postage 6d.

Practical Wireless Encyclopaedia. By F. J. Camm. Price 21s. 0d. Postage 9d.

Wireless Servicing Manual. By W. T. Cocking. Price 12s. 6d. Postage 4d.

T.V. Fault Finding. Price 5s. 0d. Postage 3d.



THOSE who wish to supplement their existing knowledge with a sound technological background and, if necessary, pass qualifying examinations, can do so by means of I.C.S. Home Study Courses. These include **RADIO ENGINEERING**, **RADIO SERVICE ENGINEERING**, **ELEMENTARY ELECTRONICS**, **RADAR**, **ADVANCED SHORT WAVE RADIO**, **RADIO T.V. TECHNOLOGY and training for the following examinations—B.I.R.E., P.M.G. CERTIFICATES FOR WIRELESS OPERATORS**, C. & G. TELECOMMUNICATIONS, C. & G. RADIO SERVICING CERT. (R.T.E.B.), C. & G. RADIO AMATEURS, etc., etc. Students are coached until successful. Fees are moderate and include all books required.

GENEROUS DISCOUNT TO H.M. FORCES.
WRITE TODAY for FREE BOOKLET describing complete facilities for the successful study of Radio and T.V. technology.

INTERNATIONAL CORRESPONDENCE SCHOOLS LTD.
Dept. 183a, International Bldgs., Kingsway, London, W.C.2
Please send booklet on subject..... Age.....
Name.....
(BLOCK LETTERS PLEASE)
Address.....

Come to **SMITH'S of EDGWARE ROAD,** the friendly shop for all Radio Components

We stock everything the constructor needs—our 25 years experience of handling radio parts and accessories enables us to select the best of the regular lines and the more useful items from the surplus market in—

Loudspeakers and Phones Valves and CR Tubes
Transformers and Chokes Cabinets and Cases
Meters & Test Equipment Capacitors and Resistors
Pickups and Turntables Coils and Formers
Switches and Dials Plugs and Sockets
Metalwork and Bakelite Aerials and Insulators
Books and Tools Motors and Generators
Valve Holders and Cans Wires and Cables
Metal Rectifiers Panel Lights and Fuses
Slewing, Nuts and Bolts, Tags, Clips, Grommets and all other bits and pieces

NOTHING TOO LARGE—
NOTHING TOO SMALL

Everything you need under one roof—including all the parts specified for the popular "Viewmaster" Home-built Televisor, both London and Birmingham model.

No general catalogue is issued owing to constantly varying stocks and prices, but we shall be pleased to quote you.

H. L. SMITH & CO., LTD.
287/9 Edgware Road, London, W.2

Telephone: Paddington 5891
Hours 9 till 6 (Thursday, 1 o'clock)
Near Edgware Road Stations, Metropolitan and Bakerloo